



Metasol

Meta Solution

Contactors and Overload relays



Metasol Contactors and Overload Relays

New generation of Contactors from LSIS



Metasol Contactors

Metasol Contactors

■ Designed to show superior technology: The Metasol series

Sealed structure has improved its safety features so that no arc flash is exposed. In order to emphasize its durability as an industrial device, Metasol series adopt simple design form and sophisticated shape applying diamond cut concepts on product surface.



LSIS META SOLUTION CONTACTORS

Contents :



Table of specifications	10
Type numbering system	18
Environment	20
Connections	21
Control coil characteristics	22
Marking	24
Internal structure	25
3-pole Contactors	26
Motor starters	44
Reversing contactors	48
LED voltage monitoring contactor	50
Contactors relays	51
Latching contactors	52
4-pole Contactors	56
Enclosed motor starters, Mold enclosure	68
Enclosed motor starters, Steel enclosure	69
Capacitor contactors	70
2-pole AC Contactors, Definite purpose	71
3-pole AC Contactors, Definite purpose	72
Single-pole AC Contactors, Definite purpose	73
2-pole DC Contactors	74
Accessory	75
Overload relays	86
Overload relay specifications	88
Overload relay operation	92
Accessories for overload relay	93
Overload relay ordering types	96
Overload relay trip curves	102
Type 2 Coordination (380/415V)	110
Type 2 Coordination (440V)	113
Rated UL 508 combination motor controller Type-C	119
Rated UL 508 combination motor controller Type-F	122
Dimension	125
Comparison table	164
Certifications	170



Metasol Series completion

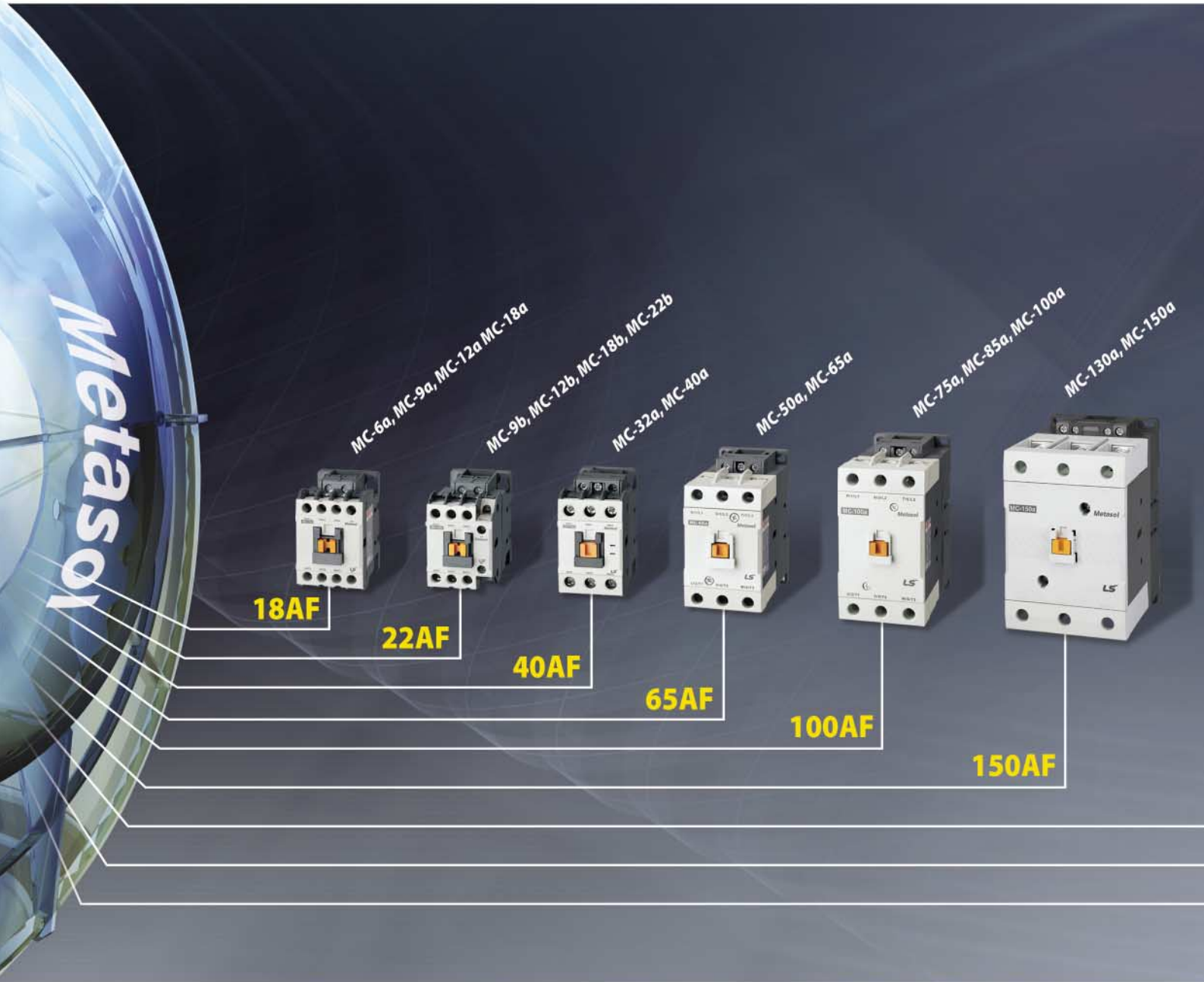

More Safe,
More Valuable



Contactors & Overload Relays



- *Advanced technology & Expert solution*
- *Offering economical solution with compact size & easy connection*
- *Ensure reliability in the system: Type II Coordination*
- *Perfect system with peripheral devices.*
- *Environment friendly product: complies with International environment standard RoHS.*
- *25Models in 9 Frames*

Contactors and Overload Relays

Motor Starters

- Compact design for space saving
- DIN rail and screw mountable (upto 150AF)
- Overload relays directly mountable to contactors separately
- Finger-proof design
- Easy to combine with manual motor starters
- Broad range of accessories
- World class products conforming to IEC and UL standards



18AF

Contactor MC-6a, 9a, 12a, 18a

Rated current: 6, 9, 12, 18A
Rated insulation voltage: 690V
Type II : 150kA @415V Max.

Overload relay MT-12

Current range: 0.1~18A
Trip class: Class10A, 20

22AF

Contactor MC-9b, 12b, 18b, 22b

Rated current: 9, 12, 18, 22A
Rated insulation voltage: 690V
Type II : 150kA @415V Max.

Overload relay MT-32

Current range: 0.1~40A
Trip class: Class10A, 20

40AF

Contactor MC-32a, 40a

Rated current: 32, 40A
Rated insulation voltage: 1000V
Type II : 150kA @415V Max.

Overload relay MT-32

Current range: 0.1~40A
Trip class: Class10A, 20

65AF

Contactor MC-50a, 65a

Rated current: 50, 65A
Rated insulation voltage: 1000V
Type II : 150kA @415V Max.

Overload relay MT-63

Current range: 4~65A
Trip class: Class10A, 20

100AF

Contactor MC-75a, 85a, 100a

Rated current: 75, 85, 100A
Rated insulation voltage: 1000V
Type II : 150kA @415V Max.

Overload relay MT-95

Current range: 7~100A
Trip class: Class10A, 20

MS-500a, MS-630a, MS-800a

MS-185a, MS-225a

MS-265a, MS-330a, MS-400a



225AF



400AF



800AF

150AF

Contactor MC-130a, 150a

Rated current: 130, 150A
Rated insulation voltage: 1000V
Type II : 150kA @415V Max.

Overload relay MT-150

Current range: 34~150A
Trip class: Class10A, 20

225AF

Contactor MC-185a, 225a

Rated current: 185, 225A
Rated insulation voltage: 1000V
Type II : 150kA @415V Max.

Overload relay MT-225

Current range: 65~240A
Trip class: Class10A, 20

400AF

Contactor MC-265a, 330a, 400a

Rated current: 265, 330, 400A
Rated insulation voltage: 1000V
Type II : 150kA @415V Max.

Overload relay MT-400

Current range: 85~400A
Trip class: Class10A, 20

800AF

Contactor MC-500a, 630a, 800a

Rated current: 500, 630, 800A
Rated insulation voltage: 1000V
Type II : 150kA @415V Max.

Overload relay MT-800

Current range: 200~800A
Trip class: Class10A, 20



MC/TOR Accessories

Perfect combination of peripheral
devices and various accessories

Offering economical solution with compact size & easy connection



Perfect system with other devices and accessories

■ One-touch connection

- Din Rail connection without any special tools
- Direct combine a surge unit

■ Simple wiring

- Mounting unit, Adapter
- Reversing wire set

■ Easy Maintenance

- 4-terminal type: Easy wiring of operation coil
- Module type of Screw terminal
- Interlock unit with built-in auxiliary contacts(2NO built-in)

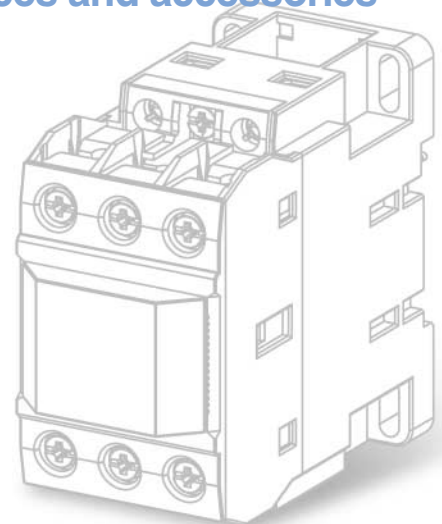

Advanced accessories for Metasol contactors

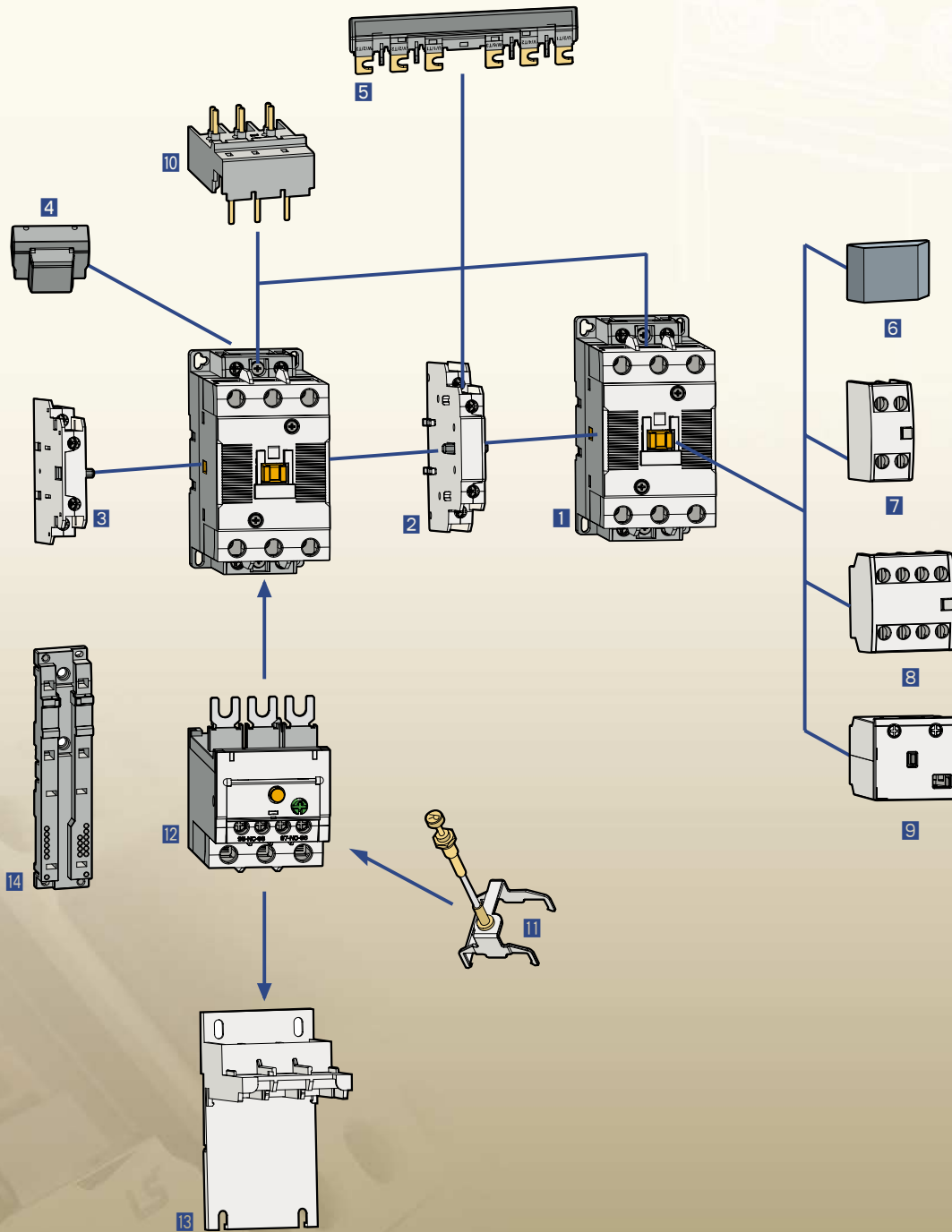

- | | | |
|--|---|-----------------------------------|
| 1 Contactor | 6 Safety cover (Option) | 10 Direct adaptor to MMS |
| 2 Interlock unit | 7 Auxiliary contact unit
- front mount(2p) | 11 Remote reset unit |
| 3 Auxiliary contact unit
- side mount | 8 Auxiliary contact unit
- front mount(4p) | 12 Overload relay |
| 4 Surge unit | 9 Mechanical latch unit | 13 Separate mounting unit |
| 5 Wire kit | | 14 Mounting unit for use with MMS |

Table of specifications

MC type Magnetic Contactors



Frame size				18AF				22AF			
Type	screws clamp terminals			MC-6a	MC-9a	MC-12a	MC-18a	MC-9b	MC-12b	MC-18b	MC-22b
Number of poles				●	●	●	●	●	●	●	●
Rated operational voltage, Ue				3pole				3pole			
Rated insulation voltage, Ui				690V				690V			
Rated frequency				50/60Hz				50/60Hz			
Rated impulse withstand voltage, Uimp				6kV				6kV			
Maximum operating rate in operating cycles per hour(AC3)				1800 operations per hour				1800 operations per hour			
Durability	Mechanical			15 mil. operations				15 mil. operations			
	Electrical			2.5 mil. operations				2.5 mil. operations			
Current and power	AC-1, Thermal current	A		25	25	25	32	25	25	40	40
	AC-3 200/240V	kW		2.2	2.5	3.5	4.5	2.5	3.5	4.5	5.5
		A		9	11	13	18	11	13	18	22
	380/440V	kW		3	4	5.5	7.5	4	5.5	7.5	11
		A		7	9	12	18	9	12	18	22
	500/550V	kW		3	4	7.5	7.5	4	7.5	7.5	15
		A		6	7	12	13	7	12	13	20
	690V	kW		3	4	7.5	7.5	4	7.5	7.5	15
	A		4	5	9	9	6	9	9	18	
	kW		-	-	-	-	-	-	-	-	-
	A		-	-	-	-	-	-	-	-	-
Rated Short-time withstand current (IEC 60947)	1s	A		210	250	280	300	250	280	300	400
	10s	A		105	110	120	130	110	120	154	186
	30s	A		70	70	80	85	70	80	100	130
	1min	A		61	61	61	70	61	61	84	90
	3min	A		40	45	47	50	45	50	60	60
	10min	A		30	30	30	40	30	30	40	50
	≥15min	A		25	26	28	40	26	28	40	45
UL rating (50/60Hz)	Continuous current		A	25	25	25	32	25	25	40	40
	Single phase	110~120V	HP	0.5	0.5	0.75	1	0.5	0.75	1	2
		220~240V	HP	1.5	1.5	2	3	1.5	2	3	3
	Three phase	200~208V	HP	2	2	3	5	2	3	5	7.5
		220~240V	HP	3	3	5	7.5	3	5	7.5	10
		440~480V	HP	5	5	7.5	10	5	7.5	10	15
	550~600V	HP	7.5	7.5	10	15	7.5	10	15	20	
NEMA size			00	00	0	1	00	00	1		
Size and weight	AC control	Weight	kg	0.33				0.34			
		Size(W × H × D)	mm	45 × 73.5 × 80.4				45 × 73.5 × 87.4			
weight	DC control	Weight	kg	0.4				0.41			
		Size(W × H × D)	mm	45 × 73.5 × 96.6				45 × 73.5 × 103.6			
Auxiliary(standard)				1NO or 1NC				1NO1NC			
Auxiliary	Side mount			UA-1				UA-1			
	Front mount			UA-2, UA-4				UA-2, UA-4			

Note) Minimum conduct current of Auxiliary contactor is DC 17V 5mA.

MT type Thermal Overload Relays



Type	Screws clamp terminals			MT-12/□		MT-32/□	
Rated operational voltage, Ue				690V		690V	
Rated insulation voltage, Ui				690V		690V	
Rated impulse withstand voltage, Uimp				6kV		6kV	
Trip class				10A, 20		10A, 20	
Setting range				0.1~18A		0.1~40A	
Size and weight		Weight	kg	0.1		0.17	
		Size(W × H × D)	mm	45 × 73.2 × 63.7		45 × 75 × 90	

* The safety cover of magnetic contactor and thermal overload relay is optional.



40AF

MC-32a	MC-40a
●	●
3pole	
690V	
1000V	
50/60Hz	
8kV	
1800 operations per hour	
12 mil. operations	
2 mil. operations	
50	60
7.5	11
32	40
15	18.5
32	40
18.5	22
28	32
18.5	22
20	23
22	22
17	17
600	700
260	300
160	190
100	120
70	80
55	65
50	60
50	60
2	3
5	7.5
7.5	15
10	15
20	30
25	30
1P	2
0.4	
45 × 83 × 90	
0.6	
45 × 83 × 117.1	

2NO2NC

UA-1
UA-2, UA-4



65AF

MC-50a	MC-65a
●	●
3pole	
690V	
1000V	
50/60Hz	
8kV	
1200 operations per hour	
12 mil. operations	
2 mil. operations	
70	100
15	18.5
55	65
22	30
50	65
30	33
43	60
30	33
28	35
30	33
23	26
1000	1050
550	700
330	380
250	270
150	200
90	120
87	100
70	100
3	5
10	15
20	25
25	30
40	50
50	60
0.9	
55 × 106 × 119	
1.2	
55 × 106 × 146.4	

2NO2NC

UA-1
UA-2, UA-4



100AF

MC-75a	MC-85a	MC-100a
●	●	●
3pole		
690V		
1000V		
50/60Hz		
8kV		
1200 operations per hour		
12 mil. operations		
2 mil. operations		
110	135	160
22	25	30
75	85	105
37	45	55
75	85	105
37	45	55
64	75	85
37	45	55
42	45	65
37	45	45
28	33	33
1100	1200	1320
750	800	900
400	450	500
300	350	400
220	270	270
140	170	180
114	150	160
110	135	160
5	7.5	10
15	15	20
25	30	30
30	40	40
50	60	75
60	75	75
1.6		
70 × 140 × 135.8		
2.6		
70 × 140 × 172.3		

2NO2NC

UA-1
UA-2, UA-4



MT-32/□

●
690V
690V
6kV
10A, 20
0.1~40A
0.17
45 × 75 × 90



MT-63/□

●
690V
690V
6kV
10A, 20
4~65A
0.31/0.33
55 × 81 × 100



MT-95/□

●
690V
690V
6kV
10A, 20
7~100A
0.48/0.5
70 × 97 × 110

Table of specifications

MC type Magnetic Contactors



Frame size			150AF		225AF		
Type	screws clamp terminals		MC-130a	MC-150a	MC-185a	MC-225a	
Number of poles			3pole		3pole		
Rated operational voltage, Ue			690V		690V		
Rated insulation voltage, Ui			1000V		1000V		
Rated frequency			50/60Hz		50/60Hz		
Rated impulse withstand voltage, Uimp			8kV		8kV		
Maximum operating rate in operating cycles per hour(AC3)			1200 operations per hour		1200 operations per hour		
Durability	Mechanical		5 mil. operations		5 mil. operations		
	Electrical		1 mil. operations		1 mil. operations		
Current and power	AC-1, Thermal current	A	160	210	230	275	
		kW	37	45	55	75	
	AC-3	200/240V	A	130	150	185	225
		kW	60	75	90	132	
	380/440V	A	130	150	185	225	
		kW	60	70	110	132	
	500/550V	A	90	100	180	200	
		kW	55	55	110	140	
	690V	A	60	60	120	150	
		kW	75	90	132	140	
Rated Short-time withstand current (IEC 60947)	1s	A	1350	1800	2000	2500	
	10s	A	950	1200	1500	1700	
	30s	A	700	800	1000	1200	
	1min	A	550	600	800	1000	
	3min	A	350	450	520	700	
	10min	A	200	300	350	500	
	≥ 15min	A	175	280	320	400	
UL rating (50/60Hz)	Continuous current		A	160	210	230	275
	Single phase	110~120V	HP	10	15	15	15
		220~240V	HP	20	25	30	40
		200~208V	HP	40	40	60	60
	Three phase	220~240V	HP	40	50	60	75
		440~480V	HP	75	100	125	150
	550~600V	HP	75	75	125	150	
NEMA size					4		
Size and weight	AC control	Weight	2.4		5.4		
	DC control	Size(W × H × D) mm	95 × 158 × 130.3		138 × 203 × 185.1		
Auxiliary(standard)	Side mount	Weight					
	Front mount	Size(W × H × D) mm					
Auxiliary			2NO2NC		2NO2NC		
			UA-1		AU-100, AU-100E (Max.4NO4NC)		
			UA-2, UA-4		-		

MT type Thermal Overload Relays



Type	Screws clamp terminals		MT-150/□	MT-225/□
Rated operational voltage, Ue			690V	690V
Rated insulation voltage, Ui			690V	690V
Rated impulse withstand voltage, Uimp			6kV	6kV
Trip class			10A, 20	10A, 20
Setting range			34~150A	65~240A
Size and weight	Weight	kg	0.67	2.5
		Size(W × H × D) mm	95 × 109 × 113	147 × 141 × 184

* The safety cover of magnetic contactor and thermal overload relay is optional.



400AF		
MC-265a	MC-330a	MC-400a
●	●	●
	3pole	
	690V	
	1000V	
	50/60Hz	
	8kV	
	1200 operations per hour	
	5 mil. operations	2.5 mil. operations
	1 mil. operations	0.5 mil. operations
300	350	450
80	90	125
265	330	400
147	160	200
265	330	400
147	160	225
225	250	350
160	200	250
185	220	300
147	160	185
105	115	140
3500	4000	4600
2400	3000	4400
1500	2500	2974
1100	1700	1846
800	1000	1313
600	620	760
500	553	699
300	350	450
-	-	-
-	-	-
75	100	125
100	100	150
200	200	300
200	200	300
5		

800AF		
MC-500a	MC-630a	MC-800a
●	●	●
	3pole	
	690V	
	1000V	
	50/60Hz	
	8kV	
	1200 operations per hour	
	2.5 mil. operations	
	0.5 mil. operations	
580	660	900
147	190	220
500	630	800
265	330	440
500	630	800
265	330	500
400	500	720
300	400	500
380	420	630
280	355	400
220	262	288
6000	7000	7500
5050	6400	7000
4400	4500	4900
3400	3500	3800
2000	2200	2500
1400	1550	1550
1100	1300	1300
580	660	900
-	-	-
-	-	-
150	200	200
200	250	300
400	500	600
400	500	600
6		7

9.2
163 × 243 × 204.4

22.4
285 × 312 × 245.3

2NO2NC
AU-100, AU-100E (Max.4NO4NC)

2NO2NC
AU-100, AU-100E (Max.4NO4NC)



MT-400/□
●
690V
690V
6kV
10A, 20
85~400A
2.6
151 × 171 × 198

MT-800/□
●
690V
690V
6kV
10A, 20
200~800A
11.5
360 × 530 × 212

Table of specifications

MC type Magnetic Contactors (4pole)



Frame size			
Type	Screw clamp terminal		
Number of poles	4		
Rated operational voltage (Ue)	690V		
Rated insulation voltage (Ui)	690V		
Rated frequency	50/60Hz		
Rated impulse withstand voltage, Uimp	6kV		
Maximum operating rate in operating cycles per hour(AC1)	1800 operations per hour		
Durability	Mechanical		
	Electrical		
Current and Power	AC-1	Thermal current	A
		200/240V	kW
			A
		380/400V	kW
			A
		500/550V	kW
	A		
		690V	kW
			A
UL rating (50/60Hz)	Single	110~120V	HP
		220~240V	HP
	Phase	200~208V	HP
		220~240V	HP
	Three	440~480V	HP
		550~600V	HP
Size and weight	AC Control	Weight	kg
		Size(W × H × D)	mm
	DC Control	Weight	kg
		Size(W × H × D)	mm
Auxiliary(standard)			
Auxiliary	Side Mount		
	Front Mount		



18AF			
MC-6a/4	MC-9a/4	MC-12a/4	MC-18a/4
●			
4pole			
690V			
690V			
50/60Hz			
6kV			
1800 operations per hour			
15 mil. Operations			
0.5 mil. Operations		0.8 mil. Operations	
25	25	25	40
9	9	9	15
25	25	25	40
17	17	17	27
25	25	25	40
21	21	21	35
25	25	25	40
27	27	27	44
25	25	25	40
25	25	25	32
0.5	0.5	0.75	1
1.5	1.5	2	3
2	2	3	5
3	3	5	7.5
5	5	7.5	10
7.5	7.5	10	15
0.33			
45 × 73.5 × 79			
0.4			
45 × 73.5 × 96.6			
-			
UA-1			
UA-2, UA-4			



22AF	
MC-22a/4	
●	
4pole	
690V	
690V	
50/60Hz	
6kV	
1800 operations	
15 mil. Operations	
1 mil. Operations	
40	
15	
40	
27	
40	
35	
40	
44	
40	
32	
2	
3	
7.5	
7.5	
10	
15	
0.4	
47.2 × 80 × 86.8	
0.5	
47.2 × 80 × 113.2	
-	
AU-1	
UA-2, UA-4	

40AF	
MC-32a/4	MC-40a/4
●	
4pole	
690V	
690V	
50/60Hz	
6kV	
1800 operations per hour	
15 mil. Operations	
1 mil. Operations	
50	60
18	22
50	60
35	42
50	60
43	52
50	60
55	66
50	60
45	50
2	3
5	5
7.5	10
10	10
20	25
20	25
0.59	
59 × 83.5 × 94.5	
0.7	
59 × 83.5 × 121	
-	
AU-1	
UA-2, UA-4	

85AF			
MC-50a/4	MC-65a/4	MC-75a/4	MC-85a/4
●			
4pole			
690V			
1000V			
50/60Hz			
8kV			
1800 operations per hour			
12 mil. Operations			
1 mil. Operations			
80	100	110	135
30	37	41	51
80	100	110	135
56	70	76	95
80	100	110	135
70	88	97	120
80	100	110	135
88	110	120	150
80	100	110	135
70	80	90	100
3	5	5	7.5
7.5	10	15	15
10	15	20	25
15	20	25	30
30	40	50	50
30	40	50	50
1.2			
91 × 123.5 × 117.8			
1.29			
91 × 123.5 × 117.8			
-			
AU-1			
UA-2, UA-4			

Table of specifications

MC type Magnetic Contactors (4pole)



Frame size			
Type	Screw clamp terminal		
Number of poles	4		
Rated operational voltage (Ue)	690V		
Rated insulation voltage (Ui)	1000V		
Rated frequency	50/60Hz		
Rated impulse withstand voltage, Uimp	8kV		
Maximum operating rate in operating cycles per hour(AC1)	1200 operations per hour		
Durability	Mechanical		
	5 mil. Operations		
Current and Power	Electrical		
			0.8 mil. Operations
AC-1	Thermal current	A	
	200/240V	kW	
	380/400V	kW	
		A	
	500/550V	kW	
	690V	kW	
UL rating (50/60Hz)	Continuous current	A	
	Single	110~120V	HP
	Phase	220~240V	HP
		200~208V	HP
	Three	220~240V	HP
		Phase	440~480V
Size and weight	AC	Weight	kg
	Control	Size(W×H×D)	mm
		DC	Weight
	Control	Size(W×H×D)	mm
Auxiliary(standard)			
Auxiliary	Side Mount		
	Front Mount		



225AF				
MC-100a/4	MC-130a/4	MC-150a/4	MC-185a/4	MC-225a/4
●				
4pole				
690V				
1000V				
50/60Hz				
8kV				
1200 operations per hour				
5 mil. Operations				
0.8 mil. Operations				
160	165	250	300	330
57	60	76	87	100
150	155	200	230	260
106	110	142	165	185
150	155	200	230	260
132	137	180	205	230
150	155	200	230	260
165	170	225	255	290
150	155	200	230	260
160	160	210	230	275
7.5	10	15	15	15
15	20	25	30	40
30	40	40	60	60
30	40	50	60	75
60	75	100	125	150
60	75	100	125	150
5.6				
175 × 203 × 185				
2NO2NC				
AU-100, AU-100E				
-				

* - FLA = 722 A, LRA = 5618 A
 ** - FLA = 566 A, LRA = 4495 A



400AF

MC-265a/4	MC-330a/4	MC-400a/4
	●	
	4pole	
	690V	
	1000V	
	50/60Hz	
	8kV	
	1200 operations per hour	
	2.5 mil. Operations	
	0.5 mil. Operations	
360	420	500
115	135	160
300	350	420
215	250	300
300	350	420
265	315	375
300	350	420
335	390	470
300	350	420
300	350	450
-	-	-
-	-	-
75	100	125
100	125	150
200	250	300
200	250	300

9.9

206 × 243 × 205

2NO2NC

AU-100, AU-100E

-

800AF

MC-500a/4	MC-630a/4	MC-800a/4
	●	
	4pole	
	690V	
	1000V	
	50/60Hz	
	8kV	
	1200 operations per hour	
	2.5 mil. Operations	
	0.5 mil. Operations	
630	750	900
245	255	310
630	660	800
450	470	570
630	660	800
560	590	710
630	660	800
710	740	900
630	660	800
580	660	900
-	-	-
-	-	-
150	200	200
200	250	300
400	500	600 *
400	500	600 **

26.3

346 × 310 × 244

2NO2NC

AU-100, AU-100E

-

Type numbering system

Contactors

MC-6a / **R** / **AC220** **60Hz** **1NO1NC**

Rated current	
6a	6A
⋮	
800a	800A
9b	9A
⋮	
22b	22A

Version	
-	Standard
R	Reversing
4	4pole

Coil voltage	
AC 220	AC 220V
⋮	
DC 24	DC 24V

Frequency	
60	60Hz
50	50Hz

Auxiliary contact	
00	None
11	1NO1NC
22	2NO2NC
10	1NO
01	1NC

Note) See page 22, 23 for details.

Starters

MS-6a / **R** **2H** / **AC220** **60Hz** **10** / **0.1**

Rated current	
6a	6A
⋮	
800a	800A
9b	9A
⋮	
22b	22A

Contactor version	
-	Standard
R	Reversing

Relay version	
2H	Non-differential (2-heater)
3H	Non-differential (3-heater)
3K	Differential
3D	Class 20

Coil voltage	
AC 220	AC 220V
⋮	
DC 24	DC 24V

Frequency	
60	60Hz
50	50Hz

Auxiliary contact	
00	None
11	1NO1NC
22	2NO2NC
10	1NO
01	1NC

Relay setting current	
0.1	0.1A
⋮	
800	800A

Note) See page 22, 23 for details.

Thermal Overload Relay

MT-12 / **2H** **0.1**

Rated current	
12	12AF
32	32AF
63	63AF
95	95AF
⋮	
800	800AF

Relay version	
2H	Non-differential (2-heater)
3H	Non-differential (3-heater)
3K	Differential
3D	Class 20

Relay setting current	
0.1	0.1A
⋮	
800	800A

Contactor relays

MR / **4**



Poles	
4	4 Pole
6	6 Pole
8	8 Pole

Optional Accessories

Auxiliary contact unit

UA1

11

Version	
UA-1	Side mount
AU-100	
AU-100E	
UA-2	Front mount(2P)
UA-4	Front mount(4P)

Contact composition	
11	1NO+1NC
20	2NO
02	2NC
40	4NO
31	3NO+1NC
22	2NO+2NC
13	1NO+3NC
04	4NC

Note) UA-2: 2NO, 1NO1NC, 2NC
 UA-4: 4NO, 3NO1NC, 4NC,
 2NO2NC, 1NO3NC,

Surge absorber

US11

Composition and voltage		
1	Varistor+RC	AC 24~48V
2	Varistor+RC	AC 100~125V
3	Varistor+RC	AC 200~240V
4	Varistor+RC	DC 24~48V
5	Varistor+RC	DC 100~125V
6	Varistor+RC	DC 200~220V
11	Varistor	AC/DC 24~48V
12	Varistor	AC/DC 100~125V
13	Varistor	AC/DC 200~240V
14	Varistor	AC/DC 380~440V
22	RC	AC 100~125V

Note) See page 82 for details.

Interlock unit

UR02

Contact composition	
02	2NC
00	None

Wire kit for Interlocking

UW32

Rated current	
18	18AF
22	22AF
32	40AF
63	65AF
95	100AF

Separate mounting unit (For relay)

UZ32

Rated current	
32	32AF
63	63AF
95	95AF
150	150AF

Remote reset unit (For relay)

UM

Cable length	
4R	400
5R	500
6R	600

















Environment



Standards	IEC/EN 60947-1, IEC/EN 60947-4-1, UL508, K60947
Certifications	CE, UL, CCC
Rated insulation voltage (Ui)	1000V (6A~22A: 690V, 32A~800A: 1000V)
Rated impulse withstand voltage (Uimp)	8kV (6A~22A: 6kV, 32A~800A: 8kV)
Degree of protection	IP20 (Conforming to IEC60529)
Ambient air temperature	<p>Storage: -30° C ~ +65° C</p> <p>Operation: -5° C ~ +55° C (AC Type)</p> <p>-5° C ~ +40° C (MT, DC Type)</p> <p>-25° C ~ +60° C (MT refer to Graph)</p>
Operating altitude	3000m (8900ft)
Operating positions	
Shock resistance (1/2 sine wave =11ms)	Opened: 8G Closed: 10G
Vibration resistance (Conforming to IEC68-2-6) (5...300 Hz)	Opened: 2G Closed: 4G
Flame resistance	Conforming to UL 94: V0 Conforming to IEC 695-2-1: 960° C

Connections

Connections

Wire type		Main Terminal Size							Torque		
			(AWG / mm ²)						mm(max)	[lb-in]	[Nm]
MC-6a/9a		M3.5	18~10 / 1~6	18~10 / 1~6	18~10 / 1~6			8.3	10	1.13	12
MC-12a			16~10 / 1.5~10	16~10 / 1.5~10	16~10 / 1.5~10						
MC-18a			16~8 / 1.5~10	16~8 / 1.5~10	16~8 / 1.5~10						
MC-9b		M4	18~10 / 1~6	18~10 / 1~6	18~10 / 1~6			9.6	20	2.25	23
MC-12b			18~10 / 1~6	16~10 / 1~6	16~10 / 1~6						
MC-18b			18~10 / 1~6	16~8 / 1.5~10	16~8 / 1.5~10						
MC-22b			18~10 / 1~6	14~8 / 2.5~10	14~8 / 2.5~10						
MC-32a		M5	18~10 / 1~6	12~8 / 2.5~10	12~8 / 2.5~10			12.8	35	4	41
MC-40a			18~10 / 1~6	8~6 / 10~16	8~6 / 10~16						
MC-50a		M6	-	10~4 / 6~25	10~4 / 6~25			14	35	4	41
MC-65a			-	8~3 / 10~35	8~3 / 10~35						
MC-75a		M8	-	8~2 / 10~35	8~2 / 10~35			17	45	5.1	52
MC-85a			-	8~1/0 / 10~50	8~1/0 / 10~50						
MC-100a			-	8~2/0 / 10~70	8~2/0 / 10~70						
MC-130a		M8	-	3~2/0 / 35~70	3~2/0 / 35~70			24.5	80	9.1	93
MC-150a			-	3~4/0 / 35~95	3~4/0 / 35~95						
MC-6~150a Aux./Coil		M3.5	20~14 / 0.5~2.5	18~12 / 0.75~2.5	18~12 / 0.75~2.5			7.6	10	1.13	12
MC-185a		M10	-	1~4/0 / 50~95	1~4/0 / 50~95			25	130	14.7	150
MC-225a			-	1/0~300 / 50~150	1/0~300 / 50~150						
MC-265a		M12	-	3/0~500 / 95~240	3/0~500 / 95~240			30	200	22.6	230
MC-330a			-	4/0~500 / 95~240	4/0~500 / 95~240						
MC-400a			-	350~700 / 185~185×2	350~700 / 185~185×2						
MC-500a		M16	-	350~800 / 185~240×2	350~800 / 185~240×2			40	500	26.5	270
MC-630a			-	600~2000	-						
MC-800a			-	1700~Busbar	-						
MC-185~800a Aux./Coil		M4	16~10 / 1.25~5.5	16~10 / 1.25~5.5	16~10 / 1.25~5.5			7.6	15	1.75	18

Control coil characteristics



Frame size		18AF	22AF	40AF	65AF	100AF	150AF	
Type		MC-6a	MC-9b	MC-32a	MC-50a	MC-75a	MC-130a	
		MC-9a	MC-12b	MC-40a	MC-65a	MC-85a	MC-150a	
		MC-12a	MC-18b		MD-30a	MC-100a		
		MC-18a	MC-22b			MD-60a		
		MR-4, 6, 8				MD-100a		
AC coil								
Control voltage	[Uc]						24, 48, 100-240	
	50Hz [V]	24, 32, 36, 42, 48, 80, 100, 110, 220, 230, 240, 380, 400, 415, 440, 500, 550V					110-120, 220-240,	
	60Hz [V]	24, 48, 100, 110, 120, 200, 208, 220, 230, 240, 277, 380, 440, 480, 600V					300, 400-440, 500V	
Voltage limit	[Uc]	85 ~110%						
Coil consumption at 20°C								
AC 220V	Inrush [VA]	70	70	90	110	240	110	
60Hz	Holding [VA]	9	9	9	13	17	18	
Heat dissipation [W]		2.3	2.3	2.7	2.8	5.4	2.7	
Operating time								
	Closing [ms]	15 ... 30	15 ... 30	15 ... 30	15 ... 30	15 ... 30	20 ... 40	
	Opening [ms]	4 ... 19	4 ... 19	4 ... 19	4 ... 19	10 ... 30	60 ... 70	
DC coil								
Control voltage	[Uc]	12, 20, 24, 48, 60, 80, 100, 110, 125, 200, 220, 250V					24, 48, 70-110, 100-220, 110, 220V	
Voltage limit	[Uc]	85~110%						
Coil consumption at 20°C								
DC 110V	Inrush [W]	5	5	9	9	18	213	
	Holding [W]	5	5	9	9	18	7.5	
Time constant (L/R) [ms]		28	28	28	65	75		
Operating time								
	Closing [ms]	40 ... 60	40 ... 60	50 ... 65	50 ... 65	100 ... 120	70 ... 80	
	Opening [ms]	4 ... 19	4 ... 19	4 ... 19	4 ... 19	10 ... 25	60 ... 70	

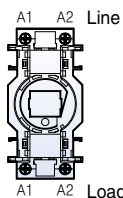

Note) A1(A2) in line side is internally connected to A1(A2) in load side.



Frame size		225AF	400AF	800AF
Type		MC-185a	MC-265a	MC-500a
		MC-225a	MC-330a	MC-630a
			MC-400a	MC-800a
AC/DC common coil				
Control voltage	[Uc]			
	AC/DC	24V/24V	-	-
	AC/DC	48V/48V	-	100V/100V
	AC/DC	100~240V/100~220V	100~240V/100~220V	200V/200V
	AC	300V	300V	300V
	AC	400V	400V	400V
	AC	500V	500V	500V
Voltage limit	[Uc]		85~110%	
Coil consumption at 20°C				
AC 220V	Inrush [VA]	380	571	1000
50/60Hz	Holding [VA]	11.6	14	29
Heat dissipation [W]		4.7	5	7.8
Operating time				
	Closing [ms]	70	55	75
	Opening [ms]	70	55	75

Marking

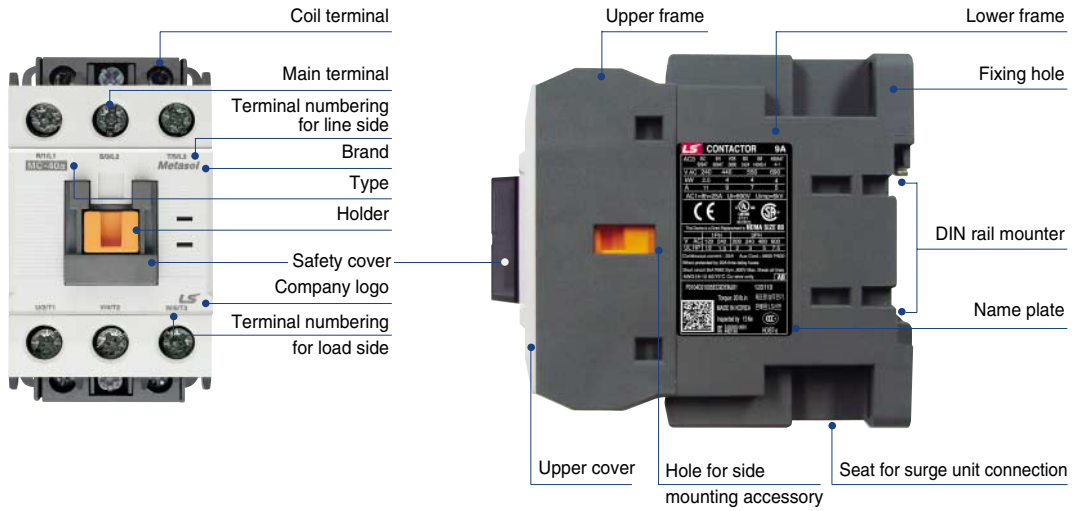

Company logo		Type
		Product name
		Rating
CE marking		UL, CSA rating
UL size		A, B : Metasol MC S : Susol MC
Wire size		Date of manufacture
Country of origin		Certification (Domestic use only)

Internal structure

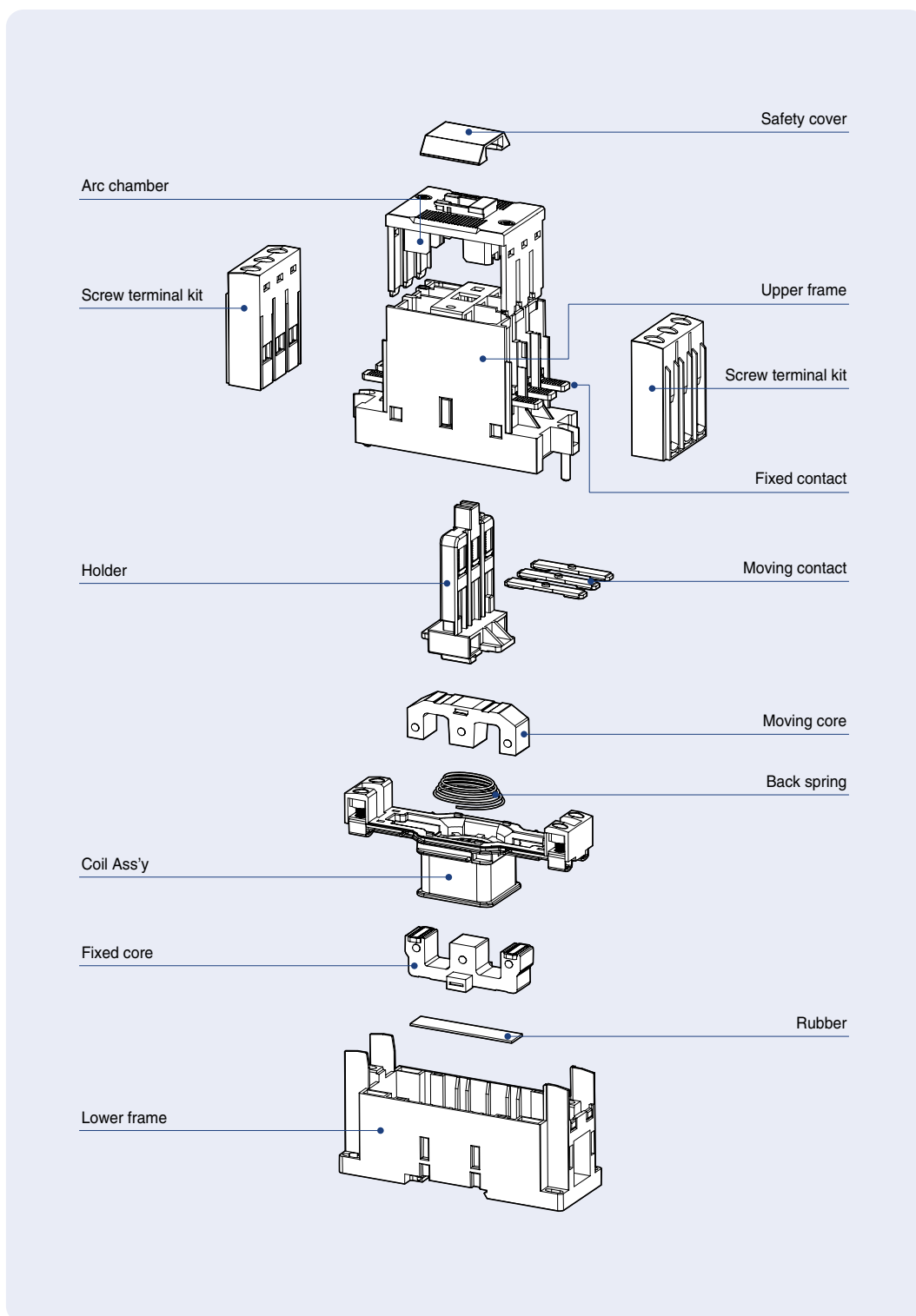

Contactors (18AF)

Description

- 3-pole(NO) main contact
- Finger proof design
- DIN rail or screw mountable
- AC or DC control in different physical size
- Front/side mountable accessories available
- Direct mountable overload relay available Rating
- 1NO or 1NC Auxiliary contact built-in as standard.

Rating



MC-18a

Contactor type			MC-6a		MC-9a		MC-12a		MC-18a		
			kW	A	kW	A	kW	A	kW	A	
AC duty	AC3	200/240V	2.2	9	2.5	11	3.5	13	4.5	18	
		380/440V	3	7	4	9	5.5	12	7.5	18	
		500/550V	3	6	4	7	7.5	12	7.5	13	
		690V	3	4	4	5	7.5	9	7.5	9	
	AC4	200/240V	1.5	7	1.5	8	2.2	11	3.7	16	
		380/440V	2.2	5	2.2	6	4	9	4	11	
AC1		-	25	-	25	-	25	-	32		
DC1 duty (L/R=1ms)	2-pole	24V	-	18	-	18	-	18	-	18	
		in series	48V	-	17	-	17	-	17	-	17
		110V	-	12	-	12	-	12	-	12	
	3-pole	24V	-	20	-	20	-	20	-	20	
		in series	48V	-	20	-	20	-	20	-	20
		110V	-	15	-	15	-	15	-	15	
DC2, 4 duty (L/R=15ms)	2-pole	24V	-	15	-	15	-	15	-	15	
		in series	48V	-	12	-	12	-	12	-	12
		110V	-	8	-	8	-	8	-	8	
	3-pole	24V	-	18	-	18	-	18	-	18	
		in series	48V	-	15	-	15	-	15	-	15
		110V	-	12	-	12	-	12	-	12	
Directly mountable Overload relay			MT-12								
Conductor size (solid, stranded)	AWG		18~10		16~10		16~8		14~8		
	(the max. number of conducts: 2)	mm ²	1~4		1.5~4		1.5~10		2.5~10		
Conductor type			65/75°C Cu-wire only								

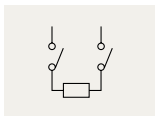

2pole for DC contact

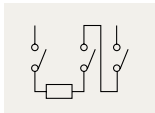

3pole for DC contact



Coil voltage

AC	50Hz	24, 32, 42, 48, 80, 100, 110, 220, 230, 240, 380, 400, 500, 550V
	60Hz	24, 48, 100, 110, 120, 200, 208, 220, 230, 240, 277, 380, 480, 600V
DC	DC	12, 20, 24, 48, 60, 80, 100, 110, 125, 200, 220, 250V

* Please be cautious for wiring control power cable, especially "+" (Positive) and "-" (Negative) polarity should be correctly considered.

Certification

- CE(IEC)
- UL508
- CCC

Accessories



Delayed opening device, AD-9
▶ 79 page

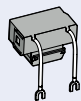

Surge unit, US
connecting to coil terminals
▶ 82 page

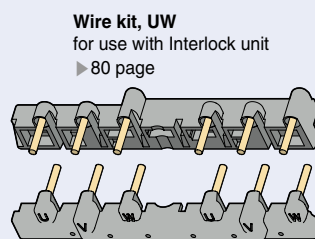

Wire kit, UW
for use with Interlock unit
▶ 80 page

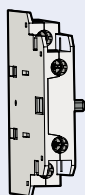

Auxiliary contact unit, UA-1
side mount, 1NO+1NC
▶ 75 page

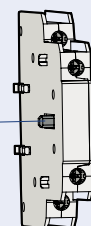
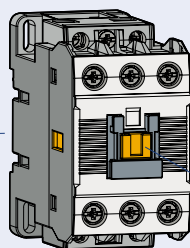

Interlock unit, UR
side mount
▶ 80 page

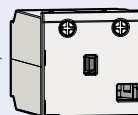

Mechanical latch unit, ML-65
▶ 78 page

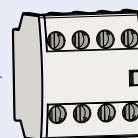

Auxiliary contact unit, UA-4
front mount, 4P
▶ 75 page

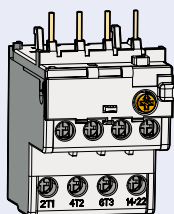

Overload relay, MT
directly mountable to MC type
contactor
▶ 88 page



Auxiliary contact unit, UA-2
front mount, 2P
▶ 75 page

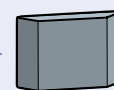

Safety cover, A7
▶ 85 page

Contactors (22AF)

Description

- 3-pole(NO) main contact
- Finger proof design
- DIN rail or screw mountable
- AC or DC control in different physical size
- Front/side mountable accessories available
- Direct mountable overload relay available Rating
- 1NO1NC Auxiliary contact built-in as standard.
- UA-1 is available on only left side

Rating



MC-22b

Contactor type			MC-9b		MC-12b		MC-18b		MC-22b		
			kW	A	kW	A	kW	A	kW	A	
AC duty	AC3	200/240V	2.5	11	3.5	13	4.5	18	5.5	22	
		380/440V	4	9	5.5	12	7.5	18	11	22	
		500/550V	4	7	7.5	12	7.5	13	15	20	
		690V	4	6	7.5	9	7.5	9	15	18	
	AC4	200/240V	1.5	8	2.2	11	3.7	16	3.7	18	
		380/440V	2.2	6	4	9	4	11	5.5	13	
	AC1		-	25	-	25	-	32	-	40	
DC1 duty (L/R=1ms)	2-pole	24V	-	18	-	18	-	18	-	32	
		in series	48V	-	17	-	17	-	17	-	30
		110V	-	12	-	12	-	12	-	23	
	3-pole	24V	-	20	-	20	-	20	-	32	
		in series	48V	-	20	-	20	-	20	-	32
		110V	-	15	-	15	-	15	-	27	
DC 2,4 duty (L/R=15ms)	2-pole	24V	-	15	-	15	-	15	-	25	
		in series	48V	-	12	-	12	-	12	-	20
		110V	-	8	-	8	-	8	-	15	
	3-pole	24V	-	18	-	18	-	18	-	30	
		in series	48V	-	15	-	15	-	15	-	30
		110V	-	12	-	12	-	12	-	20	
Directly mountable Overload relay			MT-32								
Conductor size (solid, stranded)	AWG		16~10		16~8		14~8		14~8		
	(the max. number of conducts: 2)	mm ²	1.5~4		1.5~10		2.5~10		2.5~10		
Conductor type			65/75°C Cu-wire only								

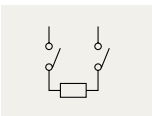

2pole for DC contact

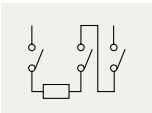

3pole for DC contact



Coil voltage

AC	50Hz	24, 32, 42, 48, 80, 100, 110, 220, 230, 240, 380, 400, 500, 550V
	60Hz	24, 48, 100, 110, 120, 200, 208, 220, 230, 240, 277, 380, 480, 600V
DC	DC	12, 20, 24, 48, 60, 80, 100, 110, 125, 200, 220, 250V

Certification

- CE(IEC)
- UL508
- CCC

* Please be cautious for wiring control power cable, especially "+" (Positive) and "-" (Negative) polarity should be correctly considered.

Accessories



Delayed opening device, AD-9
▶ 79 page

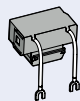

Surge unit, US
connecting to coil terminals
▶ 82 page

Wire kit, UW
for use with Interlock unit
▶ 80 page

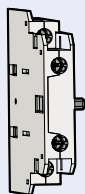
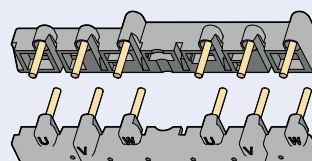

Auxiliary contact unit, UA-1
side mount, 1NO+1NC
▶ 75 page

* It is not possible to attach "UA-1" on the right side of product

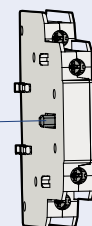
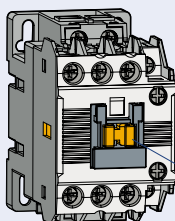

Interlock unit, UR
side mount
▶ 80 page

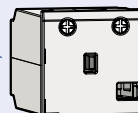

Mechanical latch unit, ML-65
▶ 78 page

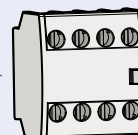

Auxiliary contact unit, UA-4
front mount, 4P
▶ 75 page



Auxiliary contact unit, UA-2
front mount, 2P
▶ 75 page

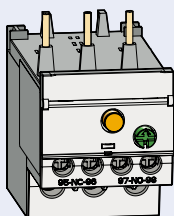

Overload relay, MT
directly mountable to MC type contactor
▶ 88 page



Safety cover, A7
▶ 85 page

Contactors (40AF)

Description

- 3-pole(NO) main contact
- Finger proof design
- DIN rail or screw mountable
- AC or DC control in different physical size
- Front/side mountable accessories available
- Direct mountable overload relay available Rating
- 2NO2NC Auxiliary contact built-in is possible as standard

Rating



MC-40a

Contactor type			MC-32a		MC-40a		
			kW	A	kW	A	
AC duty	AC3	200/240V	7.5	32	11	40	
		380/440V	15	32	18.5	40	
		500/550V	18.5	28	22	32	
		690V	18.5	20	22	23	
		1000V	22	17	22	17	
	AC4	200/240V	4.5	20	5.5	25	
		380/440V	7.5	17	11	24	
	AC1		-	50	-	60	
	DC1 (L/R=1ms)	2-pole	24V	-	32	-	55
in series			48V	-	30	-	55
110V			-	25	-	40	
3-pole		24V	-	32	-	55	
		in series	48V	-	32	-	55
		110V	-	27	-	45	
DC2,4 (L/R=15ms)	2-pole	24V	-	25	-	30	
		in series	48V	-	20	-	25
		110V	-	15	-	20	
	3-pole	24V	-	30	-	45	
		in series	48V	-	30	-	40
		110V	-	20	-	30	
Directly mountable Overload relay			MT-32				
Conductor size (solid, stranded)		AWG	12~8		8~6		
(the max. number of conducts: 2)		mm ²	2.5~10		10~16		
Conductor type			65/75°C Cu-wire only				

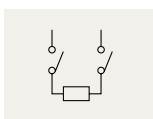

2pole for DC contact

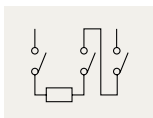

3pole for DC contact



Coil voltage

AC	50Hz	24, 32, 42, 48, 80, 100, 110, 220, 230, 240, 380, 400, 500, 550V
	60Hz	24, 48, 100, 110, 120, 200, 208, 220, 230, 240, 277, 380, 480, 600V
DC	DC	12, 20, 24, 48, 60, 80, 100, 110, 125, 200, 220, 250V

Certification

- CE(IEC)
- UL508
- CCC

Accessories



Delayed opening device, AD-9
▶ 79 page

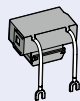

Surge unit, US
connecting to coil terminals
▶ 82 page

Wire kit, UW
for use with Interlock unit
▶ 80 page

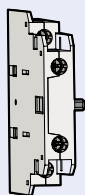
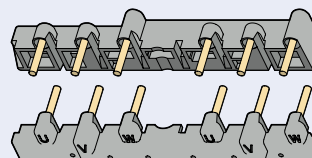

Auxiliary contact unit, UA-1
side mount, 1NO+1NC
▶ 75 page

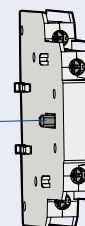
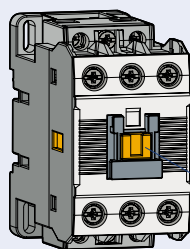

Interlock unit, UR
side mount
▶ 80 page

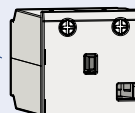

Mechanical latch unit, ML-65
▶ 78 page

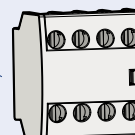

Auxiliary contact unit, UA-4
front mount, 4P
▶ 75 page



Auxiliary contact unit, UA-2
front mount, 2P
▶ 75 page

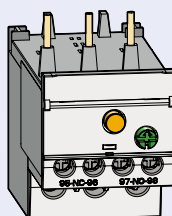

Overload relay, MT
directly mountable to MC type
contactor
▶ 89 page

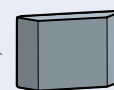

Safety cover, A7
▶ 85 page

Contactors (65AF)

Description

- 3-pole(NO) main contact
- Finger proof design
- DIN rail or screw & lug mountable
- AC or DC control in different physical size
- Front/side mountable accessories available
- Direct mountable overload relay available rating
- 2NO2NC Auxiliary contact built-in is possible as standard

Rating



MC-65a

Contactor type			MC-50a		MC-65a		
			kW	A	kW	A	
AC duty	AC3	200/240V	15	55	18.5	65	
		380/440V	22	50	30	65	
		500/550V	30	43	33	60	
		690V	30	28	33	35	
		1000V	30	23	33	26	
	AC4	200/240V	7.5	35	11	50	
		380/440V	15	32	22	47	
	AC1		-	70	-	100	
DC1 duty (L/R=1ms)	2-pole	24V	-	70	-	90	
		in series	48V	-	70	-	90
			110V	-	50	-	75
	3-pole	24V	-	70	-	90	
		in series	48V	-	70	-	90
			110V	-	60	-	80
DC2, 4 duty (L/R=15ms)	2-pole	24V	-	45	-	55	
		in series	48V	-	40	-	45
			110V	-	25	-	38
	3-pole	24V	-	55	-	75	
		in series	48V	-	50	-	65
			110V	-	35	-	55
Directly mountable Overload relay			MT-63				
Conductor size (solid, stranded)		AWG	10~4		8~3		
(the max. number of conducts: 2)		mm ²	6~25		10~35		
Conductor type			65/75°C Cu-wire only				

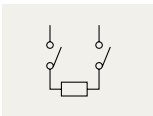

2pole for DC contact

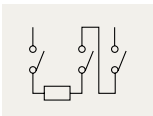

3pole for DC contact



Coil voltage

AC	50Hz	24, 32, 42, 48, 80, 100, 110, 220, 230, 240, 380, 400, 500, 550V
	60Hz	24, 48, 100, 110, 120, 200, 208, 220, 230, 240, 277, 380, 480, 600V
DC	DC	12, 20, 24, 48, 60, 80, 100, 110, 125, 200, 220, 250V

Certification

- CE(IEC)
- UL508
- CCC

Accessories



Delayed opening device, AD-50
▶ 79 page

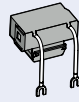

Surge unit, US
connecting to coil terminals
▶ 82 page

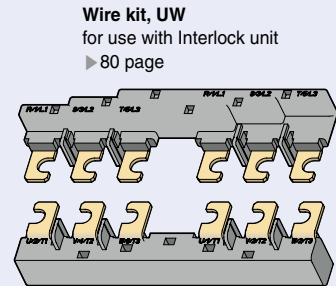

Wire kit, UW
for use with Interlock unit
▶ 80 page

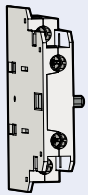

Auxiliary contact unit, UA-1
side mount, 1NO+1NC
▶ 75 page

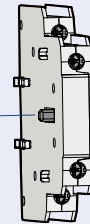
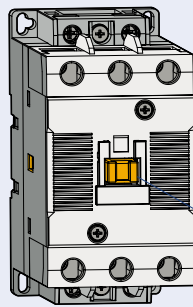

Interlock unit, UR
side mount
▶ 80 page

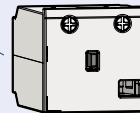

Mechanical latch unit, ML-65
▶ 78 page

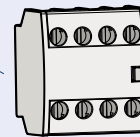

Auxiliary contact unit, UA-4
front mount, 4P
▶ 75 page



Auxiliary contact unit, UA-2
front mount, 2P
▶ 75 page

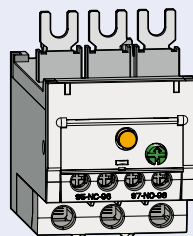

Overload relay, MT
directly mountable to MC type contactor
▶ 89 page

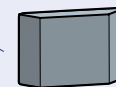

Safety cover, A7
▶ 85 page

Contactors (100AF)

Description

- 3-pole(NO) main contact
- Finger proof design
- DIN rail or screw & lug mountable
- AC or DC control in different physical size
- Front/side mountable accessories available
- Direct mountable overload relay available Rating
- 2NO2NC Auxiliary contact built-in is possible as standard

Rating



MC-100a

Contactor type			MC-75a		MC-85a		MC-100a		
			kW	A	kW	A	kW	A	
AC duty	AC3	200/240V	22	75	25	85	30	105	
		380/440V	37	75	45	85	55	105	
		500/550V	37	64	45	75	55	85	
		690V	37	42	45	45	45	65	
		1000V	37	28	45	33	45	33	
	AC4	200/240V	13	55	15	65	19	80	
		380/440V	25	52	30	62	37	75	
AC1		-	110	-	135	-	160		
DC1 duty (L/R=1ms)	2-pole	24V	-	90	-	100	-	100	
		in series	48V	-	90	-	100	-	100
		110V	-	75	-	80	-	80	
	3-pole	24V	-	90	-	100	-	100	
		in series	48V	-	90	-	100	-	100
		110V	-	80	-	85	-	85	
DC2, 4 duty (L/R=15ms)	2-pole	24V	-	55	-	60	-	60	
		in series	48V	-	45	-	50	-	50
		110V	-	38	-	40	-	40	
	3-pole	24V	-	75	-	80	-	80	
		in series	48V	-	65	-	70	-	70
		110V	-	55	-	60	-	60	
Directly mountable Overload relay			MT-95						
Conductor size (solid, stranded)	AWG		8~2		8~0		8~00		
	(the max. number of conducts: 2)	mm ²	10~35		10~50		10~70		
Conductor type			65/75°C Cu-wire only						

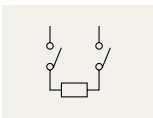

2pole for DC contact

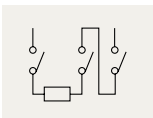

3pole for DC contact



Coil voltage

AC	50Hz	24, 32, 42, 48, 80, 100, 110, 220, 230, 240, 380, 400, 500, 550V
	60Hz	24, 48, 100, 110, 120, 200, 208, 220, 230, 240, 277, 380, 480, 600V
DC	DC	12, 20, 24, 48, 60, 80, 100, 110, 125, 200, 220, 250V

Certification

- CE(IEC)
- UL508
- CCC

Accessories



Delayed opening device, AD-50
▶ 79 page



Surge unit, US
connecting to coil terminals
▶ 82 page

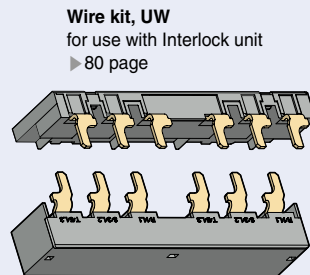

Wire kit, UW
for use with Interlock unit
▶ 80 page

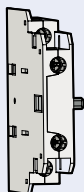

Auxiliary contact unit, UA-1
side mount, 1NO+1NC
▶ 75 page

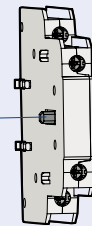
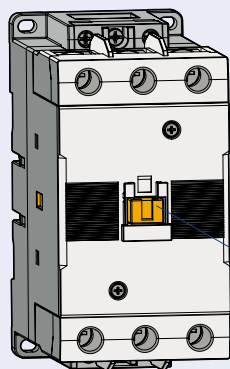

Interlock unit, UR
side mount
▶ 80 page

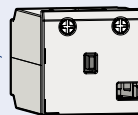

Mechanical latch unit, ML-150
▶ 78 page

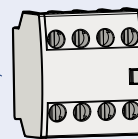

Auxiliary contact unit, UA-4
front mount, 4P
▶ 75 page



Auxiliary contact unit, UA-2
front mount, 2P
▶ 75 page

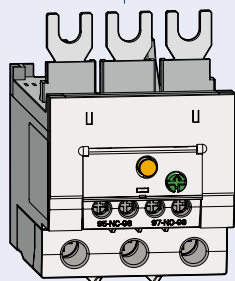

Overload relay, MT
directly mountable to MC type
contactor
▶ 89 page

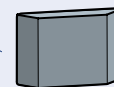

Safety cover, A7
▶ 85 page

Contactors (150AF)

Description

- 3-pole(NO) main contact
- Finger proof design
- DIN rail or screw & lug mountable
- AC or DC control in the same physical size
- Front/side mountable accessories available
- Direct mountable overload relay available
- 2NO2NC Auxiliary contact built-in is possible as standard

Rating



MC-150a

Contactor type			MC-130a		MC-150a		
			kW	A	kW	A	
AC duty	AC3	200/240V	37	130	45	150	
		380/440V	60	130	75	150	
		500/550V	60	90	70	100	
		690V	55	60	55	60	
		1000V	75	53	90	65	
	AC4	200/240V	22	93	30	120	
		380/440V	45	90	55	110	
	AC1		-	160	-	210	
DC1 duty (L/R=1ms)	2-pole	24V	-	120	-	150	
		in series	48V	-	100	-	120
		110V	-	80	-	100	
	3-pole	24V	-	120	-	150	
		in series	48V	-	120	-	150
		110V	-	100	-	150	
DC2, 4 duty (L/R=15ms)	2-pole	24V	-	120	-	150	
		in series	48V	-	60	-	100
		110V	-	40	-	80	
	3-pole	24V	-	120	-	150	
		in series	48V	-	90	-	130
		110V	-	80	-	120	
Directly mountable Overload relay			MT-150				
Conductor size (solid, stranded)		AWG	3~00		3~4/0		
(the max. number of conducts: 2)		mm ²	35~70		35~95		
Conductor type			65/75°C Cu-wire only				

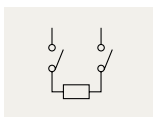

2pole for DC contact

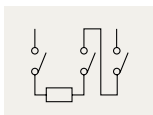

3pole for DC contact



Coil voltage

AC	50/60Hz	24, 48, 100~240, 110~120, 220~240, 300, 400~440, 500V
DC	DC	24, 48, 70~110, 100~220, 110, 220V

Certification

- CE(IEC)
- UL508
- CCC

Accessories



Delayed opening device, AD-100
▶ 79 page



Surge unit, US
connecting to coil terminals
▶ 82 page

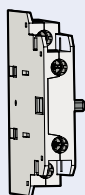

Auxiliary contact unit, UA-1
side mount, 1NO+1NC
▶ 75 page

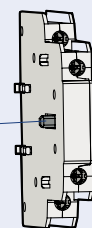
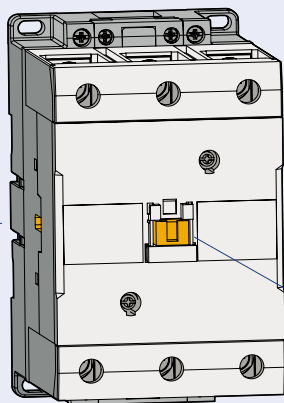

Interlock unit, UR
side mount
▶ 80 page

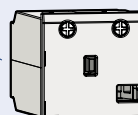

Mechanical latch unit, ML-150
▶ 78 page

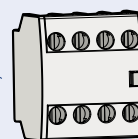

Auxiliary contact unit, UA-4
front mount, 4P
▶ 75 page



Auxiliary contact unit, UA-2
front mount, 2P
▶ 75 page

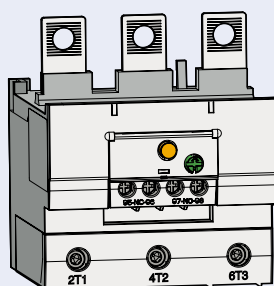

Overload relay, MT
directly mountable to MC type contactor
▶ 90 page



Safety cover, A7
▶ 85 page

Contactors (225AF)

Description

- 3-pole main contact
- AC/DC common use coil built
- Wide coil operation voltage
- Screw mountable
- 2NO+2NC Auxiliary contacts built-in as standard
- Top/side mountable accessories available
- Direct mountable overload relays available

Rating



MC-225a

Contactor type			MC-185a		MC-225a		
			kW	A	kW	A	
AC duty	AC3	200/240V	55	185	75	225	
		380/440V	90	185	132	225	
		500/550V	110	180	132	200	
		690V	110	120	140	150	
		1000V	132	90	140	100	
	AC4	200/240V	37	150	45	180	
		380/440V	75	150	90	180	
AC1		-	230	-	275		
DC1 duty (L/R=1ms)	2-pole	24V	-	180	-	220	
		in series	48V	-	180	-	180
		110V	-	150	-	150	
	3-pole	24V	-	180	-	220	
		in series	48V	-	180	-	220
		110V	-	180	-	220	
DC2, 4 duty (L/R=15ms)	2-pole	24V	-	180	-	220	
		in series	48V	-	150	-	150
		110V	-	120	-	120	
	3-pole	24V	-	180	-	220	
		in series	48V	-	180	-	220
		110V	-	150	-	150	
Directly mountable Overload relay			MT-225				
Conductor size (solid, stranded) (the max. number of conducts: 2)	AWG		1~4/0		0~300		
	mm ²		50~95		50~150		
Conductor type			75°C Cu stranded wire				

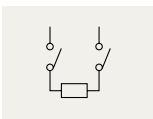

2pole for DC contact

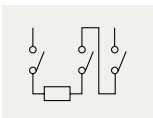

3pole for DC contact



Coil voltage, AC/DC common

Nominal(ordering) voltage	AC 50/60Hz	DC
24V	24 - 25V	24V
48V	48 - 50V	48V
100/200V	100 - 240V	100 - 220V
300V	265 - 347V	-
400V	380 - 450V	-
500V	440 - 575V	-

Certification

- CE(IEC)
- UL508
- CCC

Accessories



AD-100
Delayed opening device
▶ 79 page

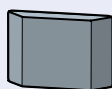

Safety cover, A7
▶ 85 page



AP-220
Terminal cover
▶ 79 page



AI-180
Insulation barrier
▶ 79 page



AU-100, 100E
Auxiliary contact unit
side mount, 1NO+1NC
▶ 76 page



AR-180
Interlock unit
side mount
▶ 81 page



MT-225
Overload relay
directly mountable to the contactor
Current range 65-240A
▶ 91 page

Contactors (400AF)

Description

- 3-pole main contact
- AC/DC common use coil built
- Wide coil operation voltage
- Screw mountable
- 2NO+2NC Auxiliary contacts built-in as standard
- Top/side mountable accessories available
- Direct mountable overload relays available

Rating



MC-400a

Contactor type			MC-265a		MC-330a		MC-400a		
			kW	A	kW	A	kW	A	
AC duty	AC3	200/240V	80	265	90	330	125	400	
		380/440V	147	265	160	330	200	400	
		500/550V	147	225	160	250	225	350	
		690V	160	185	200	220	250	300	
		1000V	147	105	160	115	185	140	
	AC4	200/240V	50	200	55	220	75	300	
		380/440V	102	200	110	220	150	300	
AC1		-	300	-	350	-	450		
DC1 duty (L/R=1ms)	2-pole	24V	-	220	-	300	-	400	
		in series	48V	-	180	-	240	-	240
		110V	-	150	-	200	-	200	
	3-pole	24V	-	220	-	300	-	400	
		in series	48V	-	220	-	300	-	400
		110V	-	220	-	300	-	400	
DC2, 4 duty (L/R=15ms)	2-pole	24V	-	220	-	300	-	400	
		in series	48V	-	150	-	200	-	200
		110V	-	120	-	150	-	150	
	3-pole	24V	-	220	-	300	-	400	
		in series	48V	-	220	-	280	-	280
		110V	-	150	-	200	-	200	
Directly mountable Overload relay			MT-400						
Conductor size (solid, stranded) (the max. number of conducts: 2)		AWG	3/0~500		4/0~500		350~700		
		mm ²	95~240		95~240		185~370		
Conductor type			75°C Cu stranded wire						

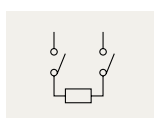

2pole for DC contact

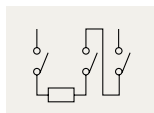

3pole for DC contact



Coil voltage, AC/DC common

Nominal(ordering) voltage	AC 50/60Hz	DC
100/200V	100 - 240V	100 - 220V
300V	265 - 347V	-
400V	380 - 450V	-
500V	440 - 575V	-

Certification
• CE(IEC)
• UL508
• CCC

Accessories



AD-300
Delayed opening device
▶ 79 page

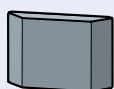

Safety cover, A7
▶ 85 page



AP-400
Terminal cover
▶ 79 page



AI-180
Insulation barrier
▶ 79 page



AU-100, 100E
Auxiliary contact unit
side mount, 1NO+1NC
▶ 76 page



AR-180
Interlock unit
side mount
▶ 81 page

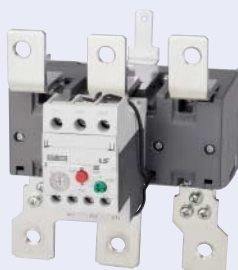

MT-400
Overload relay
directly mountable to the contactor
Current range 85–400A
▶ 91 page

Contactors (800AF)

Description

- 3-pole main contact
- AC/DC common use coil built
- Wide coil operation voltage
- Screw mountable
- 2NO+2NC Auxiliary contacts built-in as standard
- Top/side mountable accessories available
- Overload relays available

Rating



MC-800a

Contactor type			MC-500a		MC-630a		MC-800a		
			kW	A	kW	A	kW	A	
AC duty	AC3	200/240V	147	500	190	630	220	800	
		380/440V	265	500	330	630	440	800	
		500/550V	265	400	330	500	500	720	
		690V	300	380	400	420	500	630	
		1000V	280	220	355	262	400	288	
	AC4	200/240V	90	350	110	400	160	630	
		380/440V	176	350	200	400	300	630	
	AC1		-	580	-	660	-	900	
DC1 duty (L/R=1ms)	2-pole	24V	-	400	-	630	-	800	
		in series	48V	-	240	-	630	-	800
		110V	-	200	-	630	-	630	
	3-pole	24V	-	400	-	630	-	800	
		in series	48V	-	400	-	630	-	800
		110V	-	400	-	630	-	800	
DC2, 4 duty (L/R=15ms)	2-pole	24V	-	400	-	630	-	800	
		in series	48V	-	200	-	630	-	630
		110V	-	150	-	630	-	630	
	3-pole	24V	-	400	-	630	-	800	
		in series	48V	-	280	-	630	-	630
		110V	-	200	-	630	-	630	
Directly mountable Overload relay			MT-800						
Conductor size (solid, stranded)	AWG		350~800		600~2000		1700~Busbar		
	mm ²	(the max. number of conducts: 2)	185~480		-		-		
Conductor type			75°C Cu stranded wire						

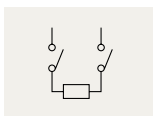

2pole for DC contact

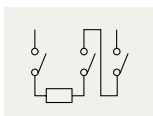

3pole for DC contact



Coil voltage, AC/DC common

Nominal(ordering) voltage	AC 50/60Hz	DC
100V	100 - 127V	100 - 110V
200V	200 - 240V	200 - 220V
300V	265 - 347V	-
400V	380 - 450V	-
500V	440 - 575V	-

Certification
<ul style="list-style-type: none"> • CE(IEC) • UL508 • CCC

Accessories

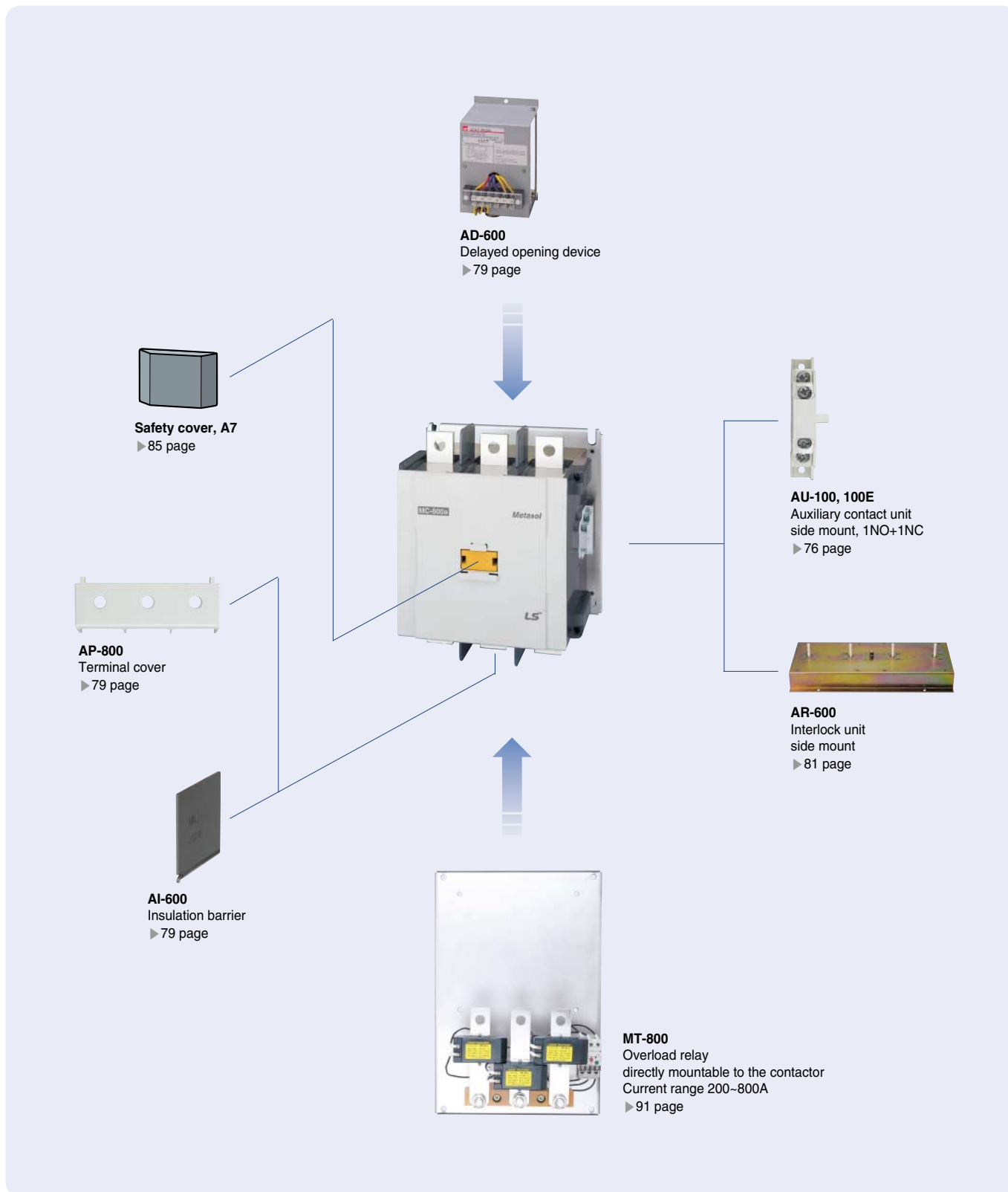

Motor starters

Description

- Opened direct motor starter
- 3-pole(NO) main contact
- Finger proof design
- DIN rail or screw mountable
- AC or DC control contactor selectable
- Front/side mountable accessories available
- Overload relay is directly mounted to the contactor



Rating

Starter type	18AF				22AF			
	MS-6a	MS-9a	MS-12a	MS-18a	MS-9b	MS-12b	MS-18b	MS-22b
Number of poles	3				3			
Rated operational voltage (Ue)	690V				690V			
Degree of pollution (IEC60529)	IP20				IP20			
Rated operational current Ie ($\theta \leq 40^\circ\text{C}$)								
AC-1 Ue max 690V A	25	25	25	32	25	25	32	40
AC-3 200/240V A	9	11	13	18	11	13	18	22
380/400V A	7	9	12	18	9	12	18	22
415V A	7	9	12	18	9	12	18	22
440V A	7	9	12	18	9	12	18	22
500V A	6	7	12	13	7	12	13	20
690V A	4	5	9	9	6	9	9	18
1000V A	-	-	-	-	-	-	-	-
Rated operational power ($\theta \leq 40^\circ\text{C}$)								
AC-3 200/240V kW	2.2	2.5	3.5	4.5	2.5	3.5	4.5	5.5
380/400V kW	3	4	5.5	7.5	4	5.5	7.5	11
415V kW	3	4	5.5	7.5	4	5.5	7.5	11
440V kW	3	4	5.5	7.5	4	5.5	7.5	11
500V kW	3	4	7.5	7.5	4	7.5	7.5	15
690V kW	3	4	7.5	7.5	4	7.5	7.5	15
1000V kW	-	-	-	-	-	-	-	-
According to IEC60947-4-1								
Rated making capacity AC-3	70	90	120	180	90	120	180	220
Rated breaking capacity AC-3	56	72	96	144	72	96	144	176
Electrical life for Ie/AC-3 Max in millions of operating cycles	2.5	2.5	2.5	2.5	2.5	2.5	2.5	2.5
Maximum operating rate in operating cycles per hour	1800	1800	1800	1800	1800	1800	1800	1800

Devices usable in the starter combination

Contactors		18AF				22AF			
		MC-6a	MC-9a	MC-12a	MC-18a	MC-9b	MC-12b	MC-18b	MC-22b
with AC or DC control coil									
with coil in common use for AC and DC		-	-	-	-	-	-	-	-
Thermal Overload Relays									
Class 10A	Differential type	MT-12/3K				MT-32/3K			
	Non-differential type	MT-12/3H				MT-32/3H			
	Non-differential type(2-heater)	MT-12/2H				MT-32/2H			
Class 20	Differential type	MT-12/3D				MT-32/3D			
	Setting range A	0.1~18A				0.1~40A			



40AF	
MS-32a	MS-40a
3	
690V	
IP20	
50	60
32	40
32	40
32	40
32	40
28	32
20	23
17	17
7.5	11
15	18.5
15	18.5
15	18.5
18.5	22
18.5	22
22	22
320	400
256	320
2	2
1800	1800

65AF	
MS-50a	MS-65a
3	
690V	
IP20	
70	100
55	65
50	65
50	65
50	65
43	60
28	35
23	26
15	18.5
22	30
22	30
22	30
30	33
30	33
30	33
500	650
400	520
2	2
1800	1800

100AF		
MS-75a	MS-85a	MS-100a
3		
690V		
IP20		
110	135	160
75	85	105
75	85	105
75	85	105
75	85	105
64	75	85
42	45	65
28	33	33
22	25	30
37	45	55
37	45	55
37	45	55
37	45	55
37	45	55
37	45	55
37	45	45
750	850	1050
600	650	840
2	2	2
1800	1800	1800

MC-32a	MC-40a
-	-
MT-32/3K	
MT-32/3H	
MT-32/2H	
MT-32/3D	
0.1~40A	

MC-50a	MC-65a
-	-
MT-63/3K	
MT-63/3H	
MT-63/2H	
MT-63/3D	
4~65A	

MC-75a	MC-85a	MC-100a
-	-	-
MT-95/3K		
MT-95/3H		
MT-95/2H		
MT-95/3D		
7~100A		

Motor starters

Description

- Opened direct motor starter
- 3-pole(NO) main contacts
- Screw mountable
- AC/DC common use control contactor used (from 225AF)
- Additional accessories available
- Overload relay is directly mounted to the contactor



Rating

Starter type	150AF		225AF	
	MS-130a	MS-150a	MS-185a	MS-225a
Number of poles	3		3	
Rated operational voltage (Ue)	690V		690V	
Degree of pollution (IEC60529)	IP20		IP20	
Rated operational current Ie ($\theta \leq 40^\circ\text{C}$)				
AC-1 Ue max 690V A	160	210	230	275
AC-3 200/240V A	130	150	185	225
380/400V A	130	150	185	225
415V A	130	150	185	225
440V A	130	150	185	225
500V A	90	100	180	200
690V A	60	60	120	150
1000V A	53	65	90	100
Rated operational power ($\theta \leq 40^\circ\text{C}$)				
AC-3 200/240V kW	37	45	55	75
380/400V kW	60	75	90	132
415V kW	60	75	90	132
440V kW	60	75	90	132
500V kW	60	70	110	132
690V kW	55	55	110	140
1000V kW	75	90	132	140
According to IEC60947-4-1				
Rated making capacity AC-3	1200	1500	1850	2250
Rated breaking capacity AC-3	960	1200	1480	1800
Electrical life for Ie/AC-3 Max in millions of operating cycles	1	1	1	1
Maximum operating rate in operating cycles per hour	1200	1200	1200	1200

Devices usable in the starter combination

Contactors		150AF		225AF	
		MC-130a	MC-150a	MC-185a	MC-225a
with AC or DC control coil				-	-
with coil in common use for AC and DC		-	-		
Thermal Overload Relays		150AF		225AF	
Class 10A	Differential type	MT-150/3K		MT-225/3K	
	Non-differential type	MT-150/3H		MT-225/3H	
	Non-differential type(2-heater)	MT-150/2H		MT-225/2H	
Class 20	Differential type	MT-150/3D		MT-225/3D	
	Setting range A	34-150A		65-240A	



400AF		
MS-265a	MS-330a	MS-400a
	3	
	690V	
	IP20	
300	350	450
265	330	400
265	330	400
265	330	400
265	330	400
225	250	350
185	220	300
105	115	140
80	90	125
147	160	200
147	160	200
147	160	200
147	160	225
160	200	250
147	160	185
2650	3300	4000
2120	2640	3200
1	1	0.5
1200	1200	1200

800AF		
MS-500a	MS-630a	MS-800a
	3	
	690V	
	IP20	
580	660	900
500	630	800
500	630	800
500	630	800
500	630	800
400	500	720
380	420	630
220	262	288
147	190	220
265	330	440
265	330	440
265	330	440
265	330	500
300	400	500
280	355	400
5000	6300	8000
4000	5040	6400
0.5	0.5	0.5
1200	1200	1200

-	-	-
MC-265a	MC-330a	MC-400a
	MT-400/3K	
	MT-400/3H	
	MT-400/2H	
	MT-400/3D	
	85~400A	

-	-	-
MC-500a	MC-630a	MC-800a
	MT-800/3K	
	MT-800/3H	
	MT-800/2H	
	MT-800/3D	
	200~800A	

Reversing contactors

Description

- Two AC or DC control contactors are interlocked mechanically and electrically
- 3-pole(NO) main contact in each contactor
- Finger proof design
- DIN rail or screw mountable
- Front/side mountable accessories available
- Overload relay can be directly mounted to the contactor if necessary
- Please use interval time of over 25ms

Circuit diagram

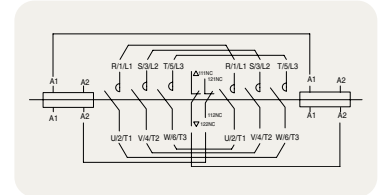

Rating

Type	AC-3 duty							Current (AC3)	Weight (AC control)
	200 ~ 240V	380 ~ 400V	415V	440V	500V	690V	1000V	440V	
	kW	kW	kW	kW	kW	kW	kW	A	
MC-6a/R	2.2	3	3	3	3	3	-	7	0.63kg
MC-9a/R	2.5	4	4	4	4	4	-	9	0.63kg
MC-12a/R	3.5	5.5	5.5	5.5	7.5	7.5	-	12	0.63kg
MC-18a/R	4.5	7.5	7.5	7.5	7.5	7.5	-	18	0.63kg
MC-9b/R	2.5	4	4	4	4	4	-	9	0.75kg
MC-12b/R	3.5	5.5	5.5	5.5	7.5	7.5	-	12	0.75kg
MC-18b/R	4.5	7.5	7.5	7.5	7.5	7.5	-	18	0.75kg
MC-22b/R	5.5	11	11	11	15	15	-	22	0.75kg
MC-32a/R	7.5	18.5	18.5	18.5	22	22	22	32	0.95kg
MC-40a/R	11	18.5	18.5	18.5	22	22	22	40	0.95kg
MC-50a/R	15	22	22	22	30	30	30	50	1.7kg
MC-65a/R	18.5	30	30	30	33	33	33	65	1.7kg
MC-75a/R	22	37	37	37	37	37	37	75	3.3kg
MC-85a/R	25	45	45	45	45	45	45	85	3.3kg
MC-100a/R	30	55	55	55	55	55	45	105	3.3kg



MC-40a/R



MC-65a/R



MC-100a/R

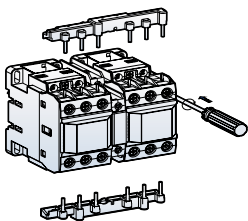

Coil voltage

AC	50Hz	24, 32, 42, 48, 80, 100, 110, 220, 230, 240, 380, 400, 500, 550V
	60Hz	24, 48, 100, 110, 120, 200, 208, 220, 230, 240, 277, 380, 480, 600V
DC	DC	12, 20, 24, 48, 60, 80, 100, 110, 125, 200, 220, 250V

Certification

- CE(IEC)
- UL508
- CCC

Description

- 3-pole main contact
- Mechanically interlocked
- AC/DC common use coil built (from MC-185a/R)
- Wide coil operation voltage
- Screw mountable
- 4NO4NC Auxiliary contacts built-in
- Top/side mountable accessories available
- Please use interval time of over 50ms



Rating

Type	AC-3 duty							Current (AC3)	Weight (AC control)
	200 ~ 240V	380 ~ 400V	415V	440V	500V	690V	1000V	440V	
	kW	kW	kW	kW	kW	kW	kW	A	
MC-130a/R	37	60	60	60	60	55	75	130	4.3kg
MC-150a/R	45	75	75	75	75	55	90	150	4.3kg
MC-185a/R	55	90	90	90	110	110	132	185	13kg
MC-225a/R	75	132	132	132	132	140	140	225	13kg
MC-265a/R	80	147	147	147	147	160	147	265	21.4kg
MC-330a/R	90	160	160	160	160	200	160	330	21.4kg
MC-400a/R	125	200	200	200	225	250	185	400	21.4kg
MC-500a/R	147	265	265	265	265	300	280	500	60kg
MC-630a/R	190	330	330	330	330	400	355	630	60kg
MC-800a/R	220	440	440	440	440	500	400	800	60kg



Coil voltage

For MC130a/R and MC-150a/R

AC	50/60Hz	24, 48, 100~240, 110~120, 220~240, 300, 400~440, 500V
DC	DC	24, 48, 70~110, 100~220, 110, 220V

For MC-185a/R ~ MC-800a/R

- 24, 48, 100/200, 300, 400, 500V for types MC-185a/R, 225a/R
- 100/200, 300, 400, 500V for types MC-265a/R, 330a/R, 400a/R
- 100, 200, 300, 400, 500V for types MC-500a/R, 600a/R, 800a/R

Nominal(ordering) voltage	AC 50/60Hz	DC
24V	24 - 25V	24V
48V	48 - 50V	48V
100V	100 - 127V	100 - 110V
200V	200 - 240V	200 - 220V
100/200V	100 - 240V	100 - 220V
300V	265 - 347V	-
400V	380 - 450V	-
500V	440 - 575V	-

LED voltage monitoring contactor

Description

- Real time observe coil voltage without additional equipments for protect coil burn out due to the under and over voltage

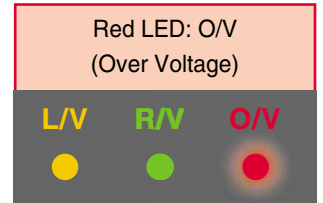
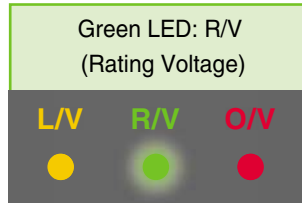
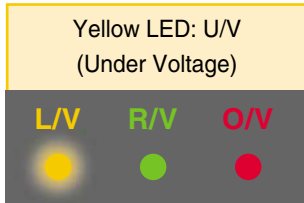

Coil voltage



Type	Coil voltage	LED indicate statue		
		Under Voltage (Yellow)	Rating Voltage (Green)	Over Voltage (Red)
MC-130a, MC 150a	110V	~80V	80~130V	130V~
	220V	~160V	160~260V	260V~
	400V	~330V	330~480V	280V~
MC-185a, MC-225a	110V	~80V	80~130V	130V~
	220V	~160V	160~260V	260V~
	400V	~330V	330~480V	280V~
MC-265a, MC-330a, MC-400a	110V	~80V	80~130V	130V~
	220V	~160V	160~260V	260V~
	400V	~330V	330~480V	280V~
MC-500a, MC-630a, MC-800a	110V	~80V	80~130V	130V~
	220V	~160V	160~260V	260V~

* The accuracy of LED indicate statue is $\pm 5\%$

Contactors relays

Description

- 4,6,8 pole units
- AC/DC control voltage
- 16A continuous current, Ith
- DIN rail or screw mountable

Selection

Poles	Composition	Types	Remarks
4 Pole	4NO 3NO1NC 2NO2NC 1NO3NC 4NC	MR-4 MR-4 Low	Additional auxiliary contacts can be mounted on the relays.
6 Pole	6NO 5NO1NC 4NO2NC 3NO3NC 2NO4NC	MR-6 MR-6 Low	UA-2 is mounted on the MR-4.
8 Pole	8NO 7NO1NC 6NO2NC 5NO3NC 4NO4NC	MR-8 MR-8 Low	UA-4 is mounted on the MR-4.

Note) Product indicated "Low" is for Low current application



MR-4



MR-6



MR-8

Ratings

Rated insulation voltage (Ui)		AC 690V						
Continuous current (Ith)		16A						
Operating cycle		1800 operations/hour						
Endurance	Mechanical life time	10 mil. Operations						
	Electrical life time	0.25 mil. Operations						
Type		MR-4	MR-6	MR-8	Low type			
AC-15	Rated current (A)	120V	6	6	6	6		
		240V	3	3	3	3		
		380V	1.9	1.9	1.9	1.9		
		480V	1.5	1.5	1.5	1.5		
		500V	1.4	1.4	1.4	1.4		
		600V	1.2	1.2	1.2	1.2		
DC-13	Rated current (A)	125V	1.1	1.1	0.55	1.1	0.55	1.1
		250V	0.55	0.55	0.27	0.55	0.27	0.55
		400V	0.31	0.31	0.15	0.31	0.15	0.31
		500V	0.27	0.27	0.13	0.27	0.13	0.27
		600V	0.2	0.2	0.1	0.2	0.1	0.2
Minimum rated through current		DC 24V 10mA					DC 5V 3mA	



Coil voltage

AC	50Hz	24, 32, 42, 48, 80, 100, 110, 220, 230, 240, 380, 400, 500, 550V
	60Hz	24, 48, 100, 110, 120, 200, 208, 220, 230, 240, 277, 380, 480, 600V
DC	DC	12, 20, 24, 48, 60, 80, 100, 110, 125, 200, 220, 250V
Voltage limit		85%~110%

Note) See page 22, 23 for details.

* Please be cautious for wiring control power cable, especially "+" (Positive) and "-" (Negative) polarity should be correctly considered.

Description

- 3-pole main contact
- Mechanically latched
- Finger proof design
- DIN rail or screw mountable
- Side mountable accessories available
- Direct mountable overload relays available

Circuit diagram

MC-6a/L~150a/L

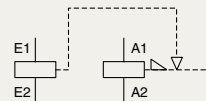

Rating

Contactor	AC3 ratings					Devices combined			
	200/240V kW	380/440V kW	500/550V kW	690V kW	1000V kW	Type	Durability (Mechanical)	Operational time	Excitation time
MC-6a/L	2.2	3	3	3	-	ML-65	0.5 mil.	Less 30ms (AC)	More than 50ms (AC)
MC-9a/L	2.5	4	4	4	-				
MC-12a/L	3.5	5.5	7.5	7.5	-				
MC-18a/L	4.5	7.5	7.5	7.5	-				
MC-9b/L	2.5	4	4	4	-				
MC-12b/L	3.5	5.5	7.5	7.5	-				
MC-18b/L	4.5	7.5	7.5	7.5	-				
MC-22b/L	5.5	11	15	15	-				
MC-32a/L	11	18.5	22	22	22				
MC-40a/L	11	18.5	22	22	22				
MC-50a/L	15	22	30	30	30				
MC-65a/L	18.5	30	33	33	33				
MC-75a/L	22	37	37	37	37				
MC-85a/L	25	45	45	45	45				
MC-100a/L	30	55	55	45	45				
MC-130a/L	37	60	60	55	75				
MC-150a/L	45	75	75	55	90				
					ML-150	2.5 mil.	Less 100ms	More than 130ms	



Coil voltage

AC	50/60Hz	24, 48, 100, 110, 120, 200, 220, 230, 240, 380, 400, 415, 440V
DC	DC	24, 48, 110V

Certification

- CE(IEC)
- UL508

Accessories

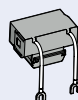

Surge unit, US
connecting to coil terminals
▶ 82 page

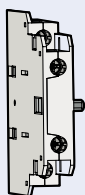

Auxiliary contact unit, UA-1
side mount, 1NO+1NC
▶ 75 page

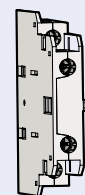

Auxiliary contact unit, UA-1
side mount, 1NO+1NC
▶ 75 page

* It is not possible to attach "UA-1" on the right side of product for Range MC-9b~22b.



Overload relay
MT-12 ~ MT-150
▶ 88 page

Description

- 3-pole main contact
- Mechanically interlocked
- AC/DC common use coil built
- Wide coil operation voltage
- Screw mountable
- 1NO+2NC Auxiliary contacts built-in as standard
- Top/side mountable accessories available



Circuit diagram

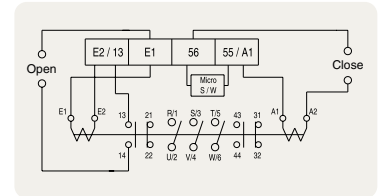

Rating

Contactor	AC3 ratings					Auxiliary contact (standard)
	200 ~ 240V	380 ~ 440V	500 ~ 550V	690V	1000V	
MC-185a/L	55kW 185A	90kW 185A	110kW 180A	110kW 120A	132kW 90A	2NO2NC
MC-225a/L	75kW 225A	132kW 225A	132kW 200A	140kW 150A	140kW 100A	
MC-265a/L	80kW 265A	147kW 265A	147kW 225A	160kW 185A	147kW 105A	
MC-330a/L	90kW 330A	160kW 330A	160kW 280A	200kW 225A	160kW 115A	
MC-400a/L	125kW 400A	200kW 400A	225kW 350A	250kW 300A	185kW 140A	

Coil voltage

Nominal(ordering) voltage	Operational voltage	Operation frequency
100V	AC100~127V	600 operations/hour
	DC100~125V	300 operations/hour
200V	AC200~240V	600 operations/hour
	DC200~220V	300 operations/hour

Accessories

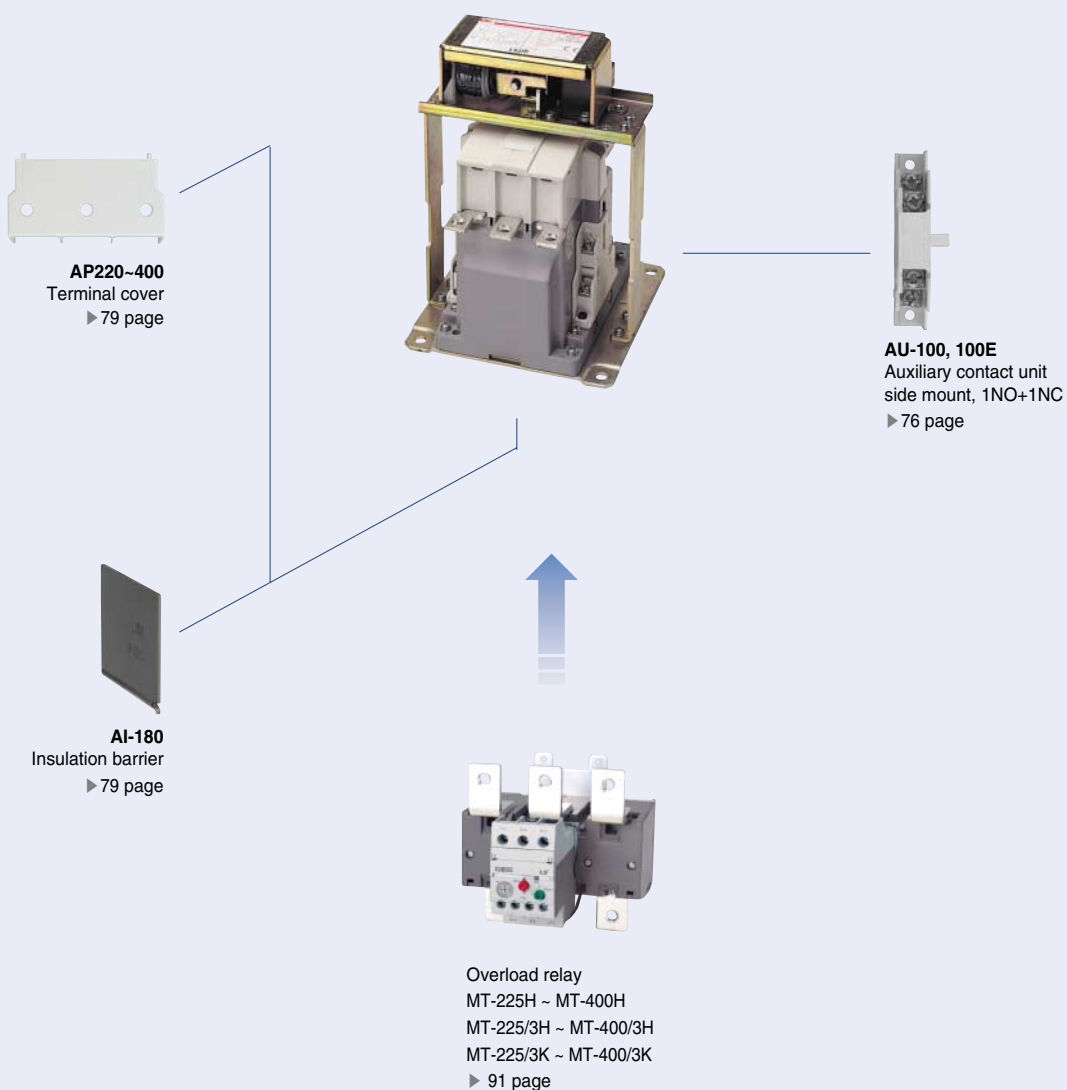

4-pole Contactors (18AF)

Description

- 4-pole main contact
- Finger proof design
- DIN rail or screw mountable
- Small physical size: 44 mm wide
- Auxiliary contacts are optional
- Front/side mountable accessories
- Direct mountable overload relays available

Rating



MC-18a/4

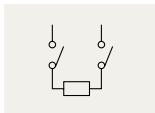

2pole for DC contact

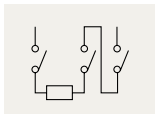

3pole for DC contact

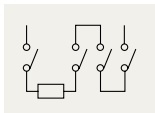

4pole for DC contact

Contactor type			MC-6a/4		MC-9a/4		MC-12a/4		MC-18a/4		
			kW	A	kW	A	kW	A	kW	A	
AC duty	AC1	200/240V	9	25	9	25	9	25	15	40	
		380/440V	17	25	17	25	17	25	27	40	
		500/550V	21	25	21	25	21	25	35	40	
		690V	27	25	27	25	27	25	44	40	
	AC3	200/240V	2.2	9	2.5	11	3.5	13	4.5	18	
		380/440V	3	7	4	9	5.5	12	7.5	18	
lth		-	25	-	25	-	25	-	40		
DC1 duty (L/R=1ms)	2-pole	110V	-	12	-	12	-	12	-	12	
	in series	220V	-	8	-	8	-	8	-	8	
	3-pole	110V	-	15	-	15	-	15	-	15	
	in series	220V	-	10	-	10	-	10	-	10	
	4-pole	110V	-	17	-	17	-	17	-	17	
	in series	220V	-	12	-	12	-	12	-	12	
UL rating			hp	A	hp	A	hp	A	hp	A	
			220/240V	3	-	3	-	5	-	7.5	-
			440/480V	5	-	5	-	7.5	-	10	-
			550/600V	7.5	-	7.5	-	10	-	15	-
			lth	-	25	-	25	-	25	-	32
Conductor size (solid, stranded)		AWG	18~10		18~10		16~10		16~8		
(the max. number of conducts: 2)		mm ²	1.5~4		1.5~10		1.5~10		1~4		
Conductor type			65/75°C Cu-wire only								



Coil voltage

AC	50Hz	24, 32, 42, 48, 80, 100, 110, 220, 230, 240, 380, 400, 500, 550V
	60Hz	24, 48, 100, 110, 120, 200, 208, 220, 230, 240, 277, 380, 480, 600V
	50/60Hz	24, 48, 100, 110, 120, 200, 220, 230, 240, 380, 415, 440, 500, 550V
DC	DC	12, 20, 24, 48, 60, 80, 100, 110, 125, 200, 220, 250V

Certification

- CE(IEC)
- UL508

Accessories



Delayed opening device, AD-9
▶ 79 page

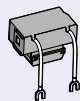

Surge unit, US
connecting to coil terminals
▶ 82 page

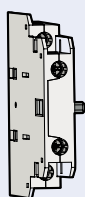

Auxiliary contact unit, UA-1
side mount, 1NO+1NC
▶ 75 page

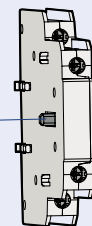

Interlock unit, UR
side mount
▶ 80 page

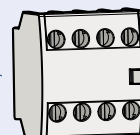

Auxiliary contact unit, UA-4
front mount, 4P
▶ 75 page



Auxiliary contact unit, UA-2
front mount, 2P
▶ 75 page

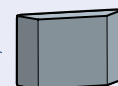

Safety cover, A7
▶ 85 page

4-pole Contactors (22, 40AF)

Description

- 4-pole main contact
- Finger proof design
- DIN rail or screw mountable
- Auxiliary contacts are optional
- Front/side mountable accessories
- Direct mountable overload relays available

Rating



MC-22a/4



MC-40a/4

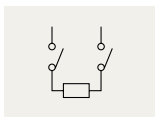

2pole for DC contact

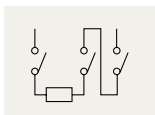

3pole for DC contact

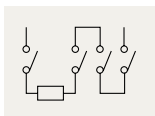

4pole for DC contact

Contactor type			MC-22a/4		MC-32a/4		MC-40a/4	
			kW	A	kW	A	kW	A
AC duty	AC1	200/240V	15	40	18	50	22	60
		380/440V	27	40	35	50	42	60
		500/550V	35	40	43	50	52	60
		690V	44	40	55	50	66	60
	AC3	200/240V	5.5	22	7.5	32	11	40
		380/440V	11	22	15	32	18.5	40
	lth	-	40	-	50	-	60	
DC1 duty (L/R=1ms) 저항/비유도성부하	2-pole	110V	-	15	-	25	-	25
	in series	220V	-	10	-	12	-	12
	3-pole	110V	-	20	-	27	-	27
	in series	220V	-	12	-	15	-	15
	4-pole	110V	-	20	-	30	-	30
	in series	220V	-	15	-	22	-	22
UL rating			hp	A	hp	A	hp	A
		220/240V	7.5	-	10	-	10	-
		440/480V	10	-	20	-	25	-
		550/600V	15	-	20	-	25	-
	lth		-	32	-	45	-	50
Conductor size (solid, stranded)		AWG	12~8		10~6		8~6	
(the max. number of conducts: 2)		mm ²	2.5~10		4~16		10~16	
Conductor type			65/75°C Cu-wire only					



Coil voltage

AC	50Hz	24, 32, 42, 48, 80, 100, 110, 220, 230, 240, 380, 400, 500, 550V
	60Hz	24, 48, 100, 110, 120, 200, 208, 220, 230, 240, 277, 380, 480, 600V
	50/60Hz	24, 48, 100, 110, 120, 200, 220, 230, 240, 380, 415, 440, 500, 550V
DC	DC	12, 20, 24, 48, 60, 80, 100, 110, 125, 200, 220, 250V

Certification

- CE(IEC)
- UL508

Accessories



Delayed opening device, AD-9
▶ 79 page



Surge unit, AS
connecting to coil terminals
▶ 82 page

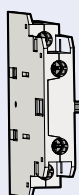

Auxiliary contact unit, AU-1
side mount, 1NO+1NC

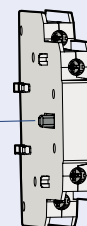

Interlock unit, AR-9
side mount

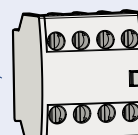

Auxiliary contact unit, UA-4
front mount, 4P
▶ 75 page



Auxiliary contact unit, UA-2
front mount, 2P
▶ 75 page

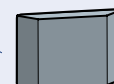

Safety cover, A7
▶ 85 page

4-pole Contactors (85AF)

Description

- 4-pole main contact
- Finger proof design
- DIN rail or screw mountable
- Auxiliary contacts are optional
- Front/side mountable accessories
- Direct mountable overload relays available

Rating



MC-85a/4

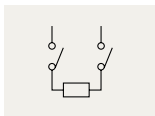

2pole for DC contact

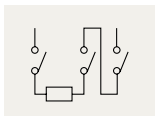

3pole for DC contact

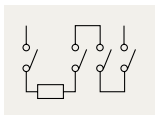

4pole for DC contact

Contactor type			MC-50a/4		MC-65a/4		MC-75a/4		MC-85a/4		
			kW	A	kW	A	kW	A	kW	A	
AC duty	AC1	200/240V	30	80	37	100	41	110	51	135	
		380/440V	56	80	70	100	76	110	95	135	
		500/550V	70	80	88	100	97	110	120	135	
		690V	88	80	110	100	120	110	150	135	
	AC3	200/240V	15	55	18.5	65	22	75	25	85	
		380/440V	22	50	30	65	37	75	45	85	
lth		-	80	-	100	-	110	-	135		
DC1 duty (L/R=1ms)	2-pole	110V	-	35	-	35	-	50	-	50	
		in series 220V	-	15	-	15	-	35	-	35	
	3-pole	110V	-	40	-	40	-	60	-	60	
		in series 220V	-	30	-	30	-	40	-	40	
	4-pole	110V	-	50	-	50	-	70	-	70	
		in series 220V	-	35	-	35	-	50	-	50	
UL rating			hp	A	hp	A	hp	A	hp	A	
			220/240V	15	-	20	-	25	-	30	-
			440/480V	30	-	40	-	50	-	50	-
			550/600V	30	-	40	-	50	-	50	-
			lth	-	70	-	80	-	90	-	100
Conductor size (solid, stranded)		AWG	8-4		6-3		4-2		4-1		
(the max. number of conducts: 2)		mm ²	10-25		16-35		25-35		25-50		
Conductor type			65/75°C Cu-wire only								



Coil voltage

AC	50Hz	24, 32, 42, 48, 80, 100, 110, 220, 230, 240, 380, 400, 500, 550V
	60Hz	24, 48, 100, 110, 120, 200, 208, 220, 230, 240, 277, 380, 480, 600V
	50/60Hz	24, 48, 100, 110, 120, 200, 220, 230, 240, 380, 415, 440, 500, 550V
DC	DC	12, 20, 24, 48, 60, 80, 100, 110, 125, 200, 220, 250V

Certification

- CE(IEC)
- UL508

Accessories



Delayed opening device, AD-50
▶ 79 page



Surge unit, AS
connecting to coil terminals
▶ 82 page

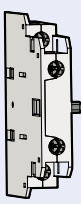

Auxiliary contact unit, AU-1
side mount, 1NO+1NC

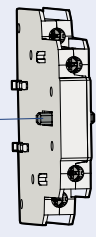

Interlock unit, AR-9
side mount

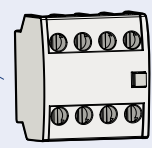

Auxiliary contact unit, UA-4
front mount, 4P
▶ 75 page



Auxiliary contact unit, UA-2
front mount, 2P
▶ 75 page

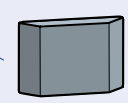

Safety cover, A7
▶ 85 page

4-pole Contactors (225AF)

Description

- 4-pole main contact
- AC/DC common use coil built
- Wide coil operation voltage
- Screw mountable
- 2NO+2NC Auxiliary contacts built-in as standard
- Side mountable accessories
- Direct mountable overload relays available

Rating



MC-225a/4

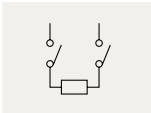

2pole for DC contact

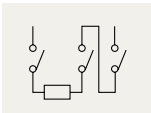

3pole for DC contact

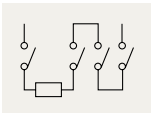

4-pole in series

Contactor type			MC-100a/4		MC-130a/4		MC-150a/4		MC-185a/4		MC-225a/4		
			kW	A	kW	A	kW	A	kW	A	kW	A	
AC duty	AC1	200/240V	57	150	60	155	76	200	87	230	100	260	
		380/440V	106	150	110	155	142	200	165	230	185	260	
		500/550V	132	150	137	155	180	200	205	230	230	260	
		690V	165	150	170	155	225	200	255	230	290	260	
	AC3	200/240V	30	105	37	125	45	150	55	185	75	225	
		380/440V	55	105	60	120	75	150	90	185	132	225	
lth		-	160	-	165	-	250	-	300	-	330		
DC1 duty (L/R=1ms)	2-pole	110V	-	80	-	80	-	100	-	150	-	150	
		in series 220V	-	50	-	50	-	100	-	150	-	150	
	3-pole	110V	-	90	-	90	-	150	-	185	-	225	
		in series 220V	-	60	-	60	-	150	-	185	-	225	
	3-pole	110V	-	100	-	100	-	150	-	185	-	225	
		in series 220V	-	80	-	80	-	150	-	185	-	225	
UL rating			hp	A	hp	A	hp	A	hp	A	hp	A	
			220/240V	30	-	40	-	50	-	60	-	75	-
			440/480V	60	-	75	-	100	-	125	-	150	-
			550/600V	60	-	75	-	100	-	125	-	150	-
			lth	-	160	-	160	-	210	-	230	-	275
Conductor size (solid, stranded)		AWG	6~00		3~00		3~4/0		1~4/0		0~300		
(the max. number of conducts: 2)		mm ²	16~70		35~70		35~95		50~95		50~150		
Conductor type			75°C Cu stranded wire										



Coil voltage, AC/DC common

Nominal(ordering) voltage	AC 50/60Hz	DC
24V	24 - 25V	24V
48V	48 - 50V	48V
100/200V	100 - 240V	100 - 220V
300V	265 - 347V	-
400V	380 - 450V	-
500V	440 - 575V	-

Certification
• CE(IEC)
• UL508

Accessories



AD-100
Delayed opening device
▶ 79 page



Safety cover, A7
▶ 85 page



AP220/4
Terminal cover
▶ 79 page



AI-180
Insulation barrier
▶ 79 page



AU-100, 100E
Auxiliary contact unit
side mount, 1NO+1NC
▶ 76 page



AR-180
Interlock unit
side mount
▶ 81 page

4-pole Contactors (400AF)

Description

- 4-pole main contact
- AC/DC common use coil built
- Wide coil operation voltage
- Screw mountable
- 2NO+2NC Auxiliary contacts built-in as standard
- Side mountable accessories

Rating



MC-400a/4

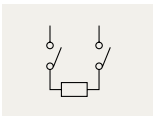

2pole for DC contact

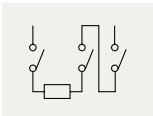

3pole for DC contact

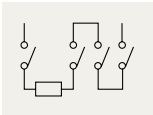

4pole for DC contact

Contactor type			MC-265a/4		MC-330a/4		MC-400a/4	
			kW	A	kW	A	kW	A
AC duty	AC1	200/240V	115	300	135	350	160	420
		380/440V	215	300	250	350	300	420
		500/550V	265	300	315	350	375	420
		690V	335	300	390	350	470	420
	AC3	200/240V	80	265	90	330	125	400
		380/440V	147	265	160	330	200	400
lth		-	360	-	420	-	500	
DC1 duty (L/R=1ms)	2-pole	110V	-	200	-	200	-	200
	in series	220V	-	200	-	200	-	200
	3-pole	110V	-	265	-	330	-	400
	in series	220V	-	265	-	330	-	400
	4-pole	110V	-	265	-	330	-	400
	in series	220V	-	265	-	330	-	400
UL rating			hp	A	hp	A	hp	A
		220/240V	100	-	125	-	150	-
		440/480V	200	-	250	-	300	-
		550/600V	200	-	250	-	300	-
		lth	-	300	-	350	-	450
Conductor size (solid, stranded)		AWG	3/0~500		4/0~500		350~700	
(the max. number of conducts: 2)		mm ²	95~240		95~240		185~370	
Conductor type			75°C Cu stranded wire					



Coil voltage, AC/DC common

Nominal(ordering) voltage	AC 50/60Hz	DC
100/200V	100 - 240V	100 - 220V
300V	265 - 347V	-
400V	380 - 450V	-
500V	440 - 575V	-

Certification

- CE(IEC)
- UL508

Accessories



AD-300
Delayed opening device
▶ 79 page



Safety cover, A7
▶ 85 page



AP-400/4
Terminal cover
▶ 79 page



AI-180
Insulation barrier
▶ 79 page



AU-100, 100E
Auxiliary contact unit
side mount, 1NO+1NC
▶ 76 page



AR-180
Interlock unit
side mount
▶ 81 page

4-pole Contactors (800AF)

Description

- 4-pole main contact
- AC/DC common use coil built
- Wide coil operation voltage
- Screw mountable
- 2NO+2NC Auxiliary contacts built-in as standard
- Side mountable accessories

Rating



MC-800a/4

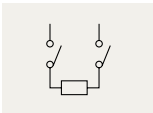

2pole for DC contact

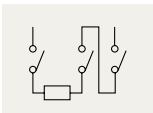

3pole for DC contact

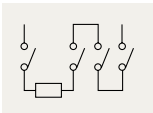

4pole for DC contact

Contactor type			MC-500a/4		MC-630a/4		MC-800a/4	
			kW	A	kW	A	kW	A
AC duty	AC1	200/240V	245	630	255	660	310	800
		380/440V	450	630	470	660	570	800
		500/550V	560	630	590	660	710	800
		690V	710	630	740	660	900	800
	AC3	200/240V	147	500	190	630	220	800
		380/440V	265	500	330	630	440	800
	lth	-	630	-	750	-	900	
DC1 duty (L/R=1ms)	2-pole	110V	-	500	-	630	-	630
		220V	-	500	-	630	-	630
	3-pole	110V	-	500	-	630	-	800
		220V	-	500	-	630	-	800
	4-pole	110V	-	500	-	630	-	800
		220V	-	500	-	630	-	800
UL rating			hp	A	hp	A	hp	A
		220/240V	200	-	250	-	300	-
		440/480V	400	-	500	-	600	-
		550/600V	400	-	500	-	600	-
		lth	-	580	-	660	-	900
Conductor size (solid, stranded)		AWG	350~800		600~2000		1700~Busbar	
(the max. number of conducts: 2)		mm ²	185~480		-		-	
Conductor type			75°C Cu stranded wire					



Coil voltage, AC/DC common

Nominal(ordering) voltage	AC 50/60Hz	DC
100V	100 - 127V	100 - 110V
200V	200 - 240V	200 - 220V
300V	265 - 347V	-
400V	380 - 450V	-
500V	440 - 575V	-

Certification

- CE(IEC)
- UL508

Accessories



AD-600
Delayed opening device
▶ 79 page

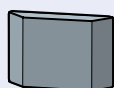

Safety cover, A7
▶ 85 page



AP-800/4
Terminal cover
▶ 79 page



AI-600
Insulation barrier
▶ 79 page



AU-100, 100E
Auxiliary contact unit
side mount, 1NO+1NC
▶ 76 page



AR-600
Interlock unit
▶ 81 page

Enclosed motor starters, Mold enclosure

Description



- Enclosed & full voltage type
- MW-□bM: Plastic enclosure without buttons
- MW-□bMB: Plastic enclosure with ON/OFF buttons
- With differential or non-differential type thermal overload relay
- Contactors: 3 pole with AC coil
- Screw mountable

Ratings



Type	AC3 Ratings				Continuous current lth	Auxiliary contact (standard)	Devices combined	
	220 ~ 240V	380 ~ 440V	500 ~ 550V	690			Contactor	Overload relay
MW-9bM(B)	2.5kW 11A	4kW 9A	4kW 7A	4kW 6A	25A	1NO1NC	MC-9b	MT-32 (0.1~22A)
MW-12bM(B)	3.5kW 13A	5.5kW 12A	7.5kW 12A	7.5kW 9A	25A		MC-12b	
MW-18bM(B)	4.5kW 18A	7.5kW 18A	7.5kW 13A	7.5kW 9A	40A		MC-18b	
MW-22bM(B)	5.5kW 22A	11kW 22A	15kW 20A	15kW 18A	40A		MC-22b	

Overload relay setting range, Amp.

MT-12		MT-32		MT-63		MT-95	
0.1 - 0.16	5 - 8	0.1 - 0.16	5 - 8	4 - 6	28 - 40	7 - 10	54 - 75
0.16 - 0.25	6 - 9	0.16 - 0.25	6 - 9	5 - 8	34 - 50	9 - 13	63 - 85
0.25 - 0.4	7 - 10	0.25 - 0.4	7 - 10	6 - 9	45 - 65	12 - 18	70 - 95
0.4 - 0.63	9 - 13	0.4 - 0.63	9 - 13	7 - 10		16 - 22	80 - 100
0.63 - 1	12 - 18	0.63 - 1	12 - 18	9 - 13		18 - 25	
1 - 1.6		1 - 1.6	16 - 22	12 - 18		24 - 36	
1.6 - 2.5		1.6 - 2.5	18 - 25	16 - 22		28 - 40	
2.5 - 4		2.5 - 4	22 - 32	18 - 25		34 - 50	
4 - 6		4 - 6	28 - 40	24 - 36		45 - 65	



Internal device



Coil voltage

AC	50Hz	24, 32, 42, 48, 80, 100, 110, 220, 230, 240, 380, 400, 500, 550V
	60Hz	24, 48, 100, 110, 120, 200, 208, 220, 230, 240, 277, 380, 480, 600V
DC		12, 20, 24, 48, 60, 80, 100, 110, 125, 200, 220, 250V

Certification

- CE(IEC)
- UL508
- CCC

Enclosed motor starters, Steel enclosure

Description



- Full voltage type
- MW-□a/MW-□b: Steel enclosure without buttons
- MW-□aB/MW-□bB: Steel enclosure ON/OFF buttons
- Contactors: 3 pole with AC coil
- Overload relay With differential or non-differential type
- Screw mountable

Ratings

Type	AC3 Ratings					Devices combined	
	220 ~ 240V	380 ~ 440V	500 ~ 550V	690V	1000V	Contactor relay	Overload
MW-6a(B)	2.2kW 9A	3kW 7A	3kW 6A	3kW 4A	-	MC-6a	MT-12 (0.1-18A)
MW-9a(B)	2.5kW 11A	4kW 9A	4kW 7A	4kW 5A	-	MC-9a	
MW-12a(B)	3.5kW 13A	5.5kW 12A	7.5kW 12A	7.5kW 9A	-	MC-12a	
MW-18a(B)	4.5kW 18A	7.5kW 18A	7.5kW 13A	7.5kW 9A	-	MC-18a	
MW-9b(B)	2.5kW 11A	4kW 9A	4kW 7A	4kW 6A	-	MC-9b	MT-32 (0.1-22A)
MW-12b(B)	3.5kW 13A	5.5kW 12A	7.5kW 12A	7.5kW 9A	-	MC-12b	
MW-18b(B)	4.5kW 18A	7.5kW 18A	7.5kW 13A	7.5kW 9A	-	MC-18b	
MW-22b(B)	5.5kW 22A	11kW 22A	15kW 20A	15kW 18A	-	MC-22b	
MW-32a(B)	7.5kW 32A	15kW 32A	18.5kW 28A	18.5kW 20A	22kW 17A	MC-32a	MT-32
MW-40a(B)	11kW 40A	18.5kW 40A	22kW 32A	22kW 23A	22kW 17A	MC-40a	(0.1-40A)
MW-50a(B)	15kW 55A	22kW 50A	30kW 43A	30kW 28A	30kW 23A	MC-50a	MT-63
MW-65a(B)	18.5kW 65A	30kW 65A	33kW 60A	33kW 35A	33kW 26A	MC-65a	(4-65A)
MW-75a(B)	22kW 75A	37kW 75A	37kW 64A	37kW 42A	37kW 28A	MC-75a	MT-95 (7-100A)
MW-85a(B)	25kW 85A	45kW 85A	45kW 75A	45kW 45A	45kW 33A	MC-85a	
MW-100a(B)	30kW 105A	55kW 105A	55kW 85A	55kW 65A	45kW 33A	MC-100a	



Internal device

Overload relay setting range, Amp.

MT-12		MT-32		MT-63		MT-95	
0.1 - 0.16	5 - 8	0.1 - 0.16	5 - 8	4 - 6	28 - 40	7 - 10	54 - 75
0.16 - 0.25	6 - 9	0.16 - 0.25	6 - 9	5 - 8	34 - 50	9 - 13	63 - 85
0.25 - 0.4	7 - 10	0.25 - 0.4	7 - 10	6 - 9	45 - 65	12 - 18	70 - 95
0.4 - 0.63	9 - 13	0.4 - 0.63	9 - 13	7 - 10		16 - 22	80 - 100
0.63 - 1	12 - 18	0.63 - 1	12 - 18	9 - 13		18 - 25	
1 - 1.6		1 - 1.6	16 - 22	12 - 18		24 - 36	
1.6 - 2.5		1.6 - 2.5	18 - 25	16 - 22		28 - 40	
2.5 - 4		2.5 - 4	22 - 32	18 - 25		34 - 50	
4 - 6		4 - 6	28 - 40	24 - 36		45 - 65	



Coil voltage

AC	50Hz	24, 32, 42, 48, 80, 100, 110, 220, 230, 240, 380, 400, 500, 550V
	60Hz	24, 48, 100, 110, 120, 200, 208, 220, 230, 240, 277, 380, 480, 600V
DC	DC	12, 20, 24, 48, 60, 80, 100, 110, 125, 200, 220, 250V

Certification
<ul style="list-style-type: none"> • CE(IEC) • UL508 • CCC

Capacitor contactors

Description

Capacitor unit(Pre-loading resistor) is connected to the terminals of the contactor to reduce the high inrush current exceeding $20 \times I_n$.

- AC or DC control coil on selection
- 3-pole(NO) main contact
- Finger proof design
- DIN rail or screw mountable
- IEC 60947-4-1 AC 6b

Rating

Type	Rating (kVar, A)			Rating thermal current (Ith)
	220 ~ 240V	400 ~ 440V	500 ~ 550V	
MC-9b with AC-9	5kVar	9.7kVar	14kVar	21.6A
	13A	14A	16A	
MC-12b with AC-9	6.7kVar	12.5kVar	18kVar	28.4A
	18A	18A	21A	
MC-18b with AC-9	8.5kVar	16.7kVar	24kVar	37.8A
	22A	24A	28A	
MC-22b with AC-9	10kVar	18kVar	26kVar	40.5A
	26A	26A	30A	
MC-32a with AC-9	15kVar	25kVar	36kVar	56.1A
	39A	36A	42A	
MC-40a with AC-9	20kVar	33.3kVar	48kVar	74.8A
	52A	48A	55A	
MC-50a with AC-50	20kVar	40kVar	58kVar	90.4A
	52A	58A	67A	
MC-65a with AC-50	25kVar	45.7kVar	66kVar	102.9A
	66A	66A	76A	
MC-75a with AC-50	29.7kVar	54kVar	78kVar	121.6A
	78A	92A	97A	
MC-85a with AC-50	35kVar	60kVar	92kVar	143.4A
	92A	87A	106A	
MC-100a with AC-50	37kVar	62kVar	94kVar	146.5A
	90A	106A	109A	

Note) - When the switch is closed condenser must be discharged before recharged. (Maximum residual voltage at terminals $\leq 50V$)
 - To prevent short current, gG type fuse must be 1.5~2 times than rated current.
 - AC-50 is including screw type and lug type.



Coil voltage

AC	50Hz	24, 32, 42, 48, 80, 100, 110, 220, 230, 240, 380, 400, 500, 550V
	60Hz	24, 48, 100, 110, 120, 200, 208, 220, 230, 240, 277, 380, 480, 600V
DC	DC	12, 20, 24, 48, 60, 80, 100, 110, 125, 200, 220, 250V

These capacitive contactors are suitable for switching single-step or multiple-step condenser bank.

It is standardized by IEC-60947-4941, UL and CSA.

Features of capacitor unit(Pre-loading resistor)

- Damping resistor that can limit the inrush current upto $60 \times I_n$ is connected to the mechanism that closed earlier than the main contact of the contactor
- No heat loss by the serial resistor
- Eliminate the switching surge
- Improving the performance of the capacitor system

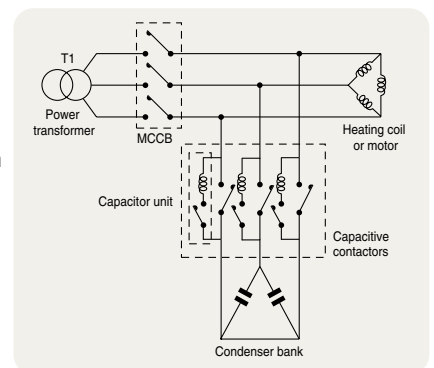

Example

2-pole AC Contactors, Definite purpose

Description



- Two normally open main contacts
- Screw clamp or fast-on connections
- Small and light design suitable for use in air conditioners, heaters, refrigerators, etc.
- Screw mountable
- No auxiliary contact
- AC control voltage

Ratings

Type	AC3 ratings			Ith	Contact	
	220~240V	380~440V	500~550V		NO	NC
GMC-10P2	10A	8A	6A	20A	2	-
GMC-20P2	20A	17A	14A	30A	2	-
GMC-25P2	25A	21A	17A	35A	2	-
GMC-30P2	30A	23A	21A	40A	2	-
GMC-35P2	35A	26A	23A	45A	2	-
GMC-40P2	40A	32A	26A	50A	2	-

Insulation voltage: 690V at AC, 250V at DC



Control coil characteristics

Coil voltage	Coil consumption (VA)		Thermal dissipation (W)	Operational voltage(V)		Coil current (mA)	Operational time (ms)	
	Inrush	Holding		Pick-up	Drop-out		Closing	Opening
24V 50/60Hz	35	6.0	2	18~20	10~15	263	40	30
48V 50/60Hz	35	6.0	2	36~40	19~27	131	40	30
100V 50/60Hz	35	6.0	2	74~81	39~57	63	40	30
110V 50/60Hz	35	6.0	2	78~90	50~64	57	40	30
120V 50/60Hz	35	6.0	2	90~100	52~66	53	40	30
200V 50/60Hz	35	6.0	2	155~165	80~115	32	40	30
220V 50/60Hz	35	6.0	2	160~175	90~120	29	40	30
230V 50/60Hz	35	6.0	2	165~180	110~130	27	40	30
240V 50/60Hz	35	6.0	2	168~185	110~135	26	40	30

Note) 1. The condition of the above data: 60Hz, 20 °C from cold state
 2. Coil consumption (VA) is average value.

Main terminal

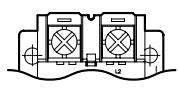

Screw clamp

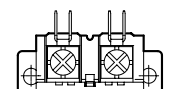

Fast-on (Quick connect)

Coil terminal

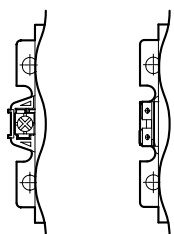

Screw clamp

Fast-on (Quick connect)

Type numbering system

GMC	/	10P		2	/	TS		BQ		100V
Contactors		Capacity (A)		Pole		Main terminal connect		Power supply connect		Operation voltage (AC)
		10P 10		2 2pole		TS Screw clamp		BS Screw clamp		20V 24V
		20P 20				TQ Quick connect		BQ Quick connect		48V 24~240V
		25P 25								110V 100~120V
		30P 30								220V 208~240V
		35P 35								
		40P 40								

3-pole AC Contactors, Definite purpose



Description

- Three main contacts
- Screw clamp connections
- Small and light design suitable for use in air conditioners, heaters, refrigerators, etc.
- Screw mountable
- No auxiliary contact
- AC control voltage

Ratings

Type	AC3 ratings			AC4 ratings			Ith	Contact	
	220~ 240V	380~ 440V	500~ 550V	220~ 240V	380~ 440V	500~ 550V		NO	NC
GMC-20D2 GMC-20D3	20A	17A	14A	18A	13A	10A	30A	2	-
3								-	
2								1	
GMC-25D2 GMC-25D3	25A	21A	17A	20A	14A	12A	35A	2	-
3								-	
2								1	

Note) Above contact ratings are for NO contact.
 Rating for NC contact: 6A@120V, 3A@240V, 1.5A@480V at AC15 duty
 Rating above 24V 1A
 Please use NC contact for Insulation voltage: 690V at AC, 250V at DC

Control coil characteristics

Coil voltage	Coil consumption (VA)		Thermal dissipation (W)	Operational voltage(V)		Coil current (mA)	Operational time (ms)	
	Inrush	Holding		Pick-up	Drop-out		Closing	Opening
24V 60Hz	72	9.0	3	17~19	12.5~15.5	215	30	20
48V 60Hz	72	9.0	3	32~36	26~30	125	30	20
110V 60Hz	72	9.0	3	75~85	65~75	60	30	20
220V 60Hz	72	9.0	3	150~170	120~145	41	30	20

Note) 1. The condition of the above data: 60Hz, 20 °C from cold state
 2. Coil consumption (VA) is average value.

Type numbering system

GMC	/	20	D2	2NO1NC	AC 220V
Contactors		Rated current	Pole	Auxiliary contact	Operation voltage (AC)
		20 20	D2 2pole	- 2pole: 2NO 3pole: 3NO	20V
		25 25	D3 3pole	2NO1NC 2NO1NC	48V
					110V
					220V

Single-pole AC Contactors, Definite purpose



Description

- Single-pole NC main contact
- Small and light design suitable for use in electric shock protector for AC arc welder
- Screw mountable
- No auxiliary contact (Optional unit can be added up to 2NO2b)
- AC control voltage

Ratings

Type	Rated current, I _n 110/220V	I _{th}	Performance	
			Making current	Breaking current
CH-6N/SP	130A	300A	1.5 × I _n	
CH-10N/SP	220A	500A		

Note) Rated current is based on the test condition in electric shock protector for AC arc welder

Control coil characteristics

Coil consumption (VA)		Operational voltage (AC 220V 60Hz)	Operational time	
Inrush	Holding		Pick-up	Drop-out
120VA	15VA	130~145V	90~100V	14~18ms

Note) Coil voltage is available between AC24V and AC50V

2-pole DC Contactors

Description



- Two normally open main contacts for DC circuit
- Positive and negative poles indicated on the front plate
- Eternal magnet installed for the effective arc extinguishing
- DIN rail or screw mountable
- 2NO+2NC Auxiliary contacts built-in as standard
- AC/DC control voltage

Selection



Contactor types	DC-2-5 ratings			Continuous current, Ith	Auxiliary contacts
	125V	250V	500V		
MD-30a	3.7kW 40A	5.5kW 30A	7.5kW 20A	60A	2NO+2NC
MD-60a	7.5kW 80A	11kW 60A	15kW 40A	100A	2NO+2NC
MD-100a	11kW 120A	18.5kW 100A	22kW 60A	135A	2NO+2NC

Ratings of auxiliary contacts

UA-1	AC15 duty						DC13 duty				
	120V	240V	380V	480V	500V	600V	125V	250V	400V	500V	600V
Rated currents	6A	3A	1.9A	1.5A	1.4A	1.2A	1.1A	0.55A	0.31A	0.27A	0.2A
Continuous current, Ith	16A										

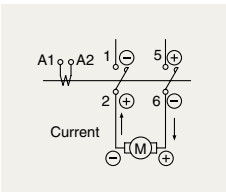

Coil voltage

AC	50/60Hz	24, 48, 100, 110, 120, 200, 220, 230, 240, 380, 400, 415, 440, 500, 550V
DC	DC	12, 20, 24, 48, 60, 80, 100, 110, 125, 200, 220, 250V

Auxiliary contact units

- 2 and 4 pole
- Side and front mountable
- Common use for Metasol contactors from MC-6a to MC-150a
- Auxiliary contact meet the requirements for mirror contacts in IEC 60947-4-1. Annex F (A mirror contact is an auxiliary NC contact that cannot be closed simultaneously with a NO main contact)
- Product indicated "Low" is for Low current application

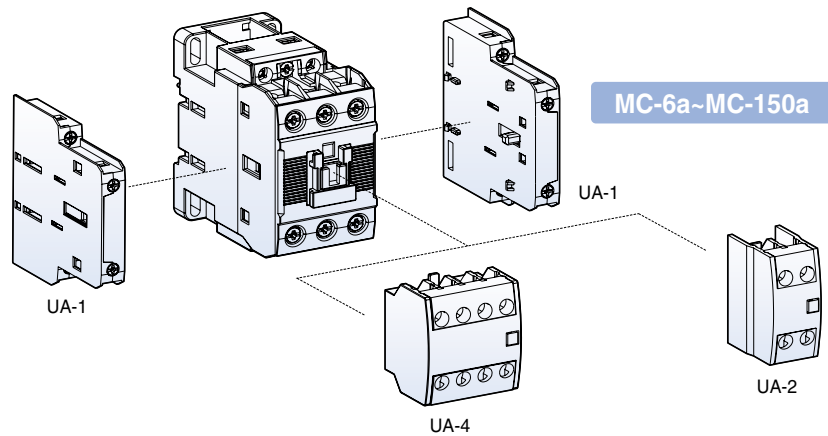

Selection

Type	Appearance	Pole	Composition		Contact arrangement	Mount	Weight
			NO	NC			
UA-1		2	1	1		Side	53g
UA-2		2	2	-		Front	28g
			1	1			
UA-4		4	-	2		Front	50g
			4	-			
			3	1			
			2	2			
			1	3			
			-	4			

Maximum combination of contact units

MC-6a-18a, 9b-22b (Max. 3a3b)	MC-32a-150a (Max. 4a4b)
UA-4(on front)+UA-1 × 1EA (1EA on one side)	UA-4(on front)+UA-1 × 2EA (1EA on both sides)
UA-2(on front)+UA-1 × 1EA (1EA on one side)	UA-2(on front)+UA-1 × 2EA (1EA on both sides)
UA-1 × 2EA (1EA on both sides)	UA-1 × 4EA (2EA on both sides) *For AC Coil

*To use UA-1, MC-9b-22b Type is available on only left side

Auxiliary contact units

- 2 pole
- Side mountable
- Common use for Metasol contactors from MC-185a to MC-800a
- Auxiliary contact meet the requirements for mirror contacts in IEC 60947-4-1. Annex F
(A mirror contact is an auxiliary NC contact that cannot be closed simultaneously with a NO main contact)

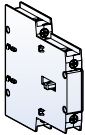
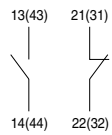

Selection

Type	Appearance	Pole	Composition		Contact arrangement	Mount	Weight
			NO	NC			
AU-100 AU-100E		2	1	1		Side	53g

Maximum combination of contact units

MC-185a~800a (Max. 4a4b)
AU-100 × 4EA (2EA on both sides)
AU-100E × 4EA (2EA on both sides)

Rating

Type		UA-1	UA-2, 4	UA-1, 2, 4 Low	AU-100	AU-100E	
Rated operation voltage (Ue)		600V	600V	600V	600V	60V	
Rated insulation voltage (Ui)		600V	600V	600V	600V	600V	
Rated impulse withstand voltage (Uimp)		6kV	6kV	6kV	6kV	6kV	
Rated frequency		50/60Hz	50/60Hz	50/60Hz	50/60Hz	50/60Hz	
Contact sensibility							
	Voltage	DC 17V	DC 24V	DC 5V	DC 24V	DC 7V	
	Current	DC 5mA	DC 10mA	DC 3mA	DC 10mA	DC 5mA	
Rated thermal current (Ith, AC12 duty)		10A	16A	16A	16A	1A	
Rated operation current							
	AC15 duty (A600)	120V	6A	6A	6A	6A	AC/DC 24V 0.1A AC/DC 50V 0.01A
		240V	3A	3A	3A	3A	
		380V	1.9A	1.9A	1.9A	1.9A	
		480V	1.5A	1.5A	1.5A	1.5A	
		500V	1.4A	1.4A	1.4A	1.4A	
		600V	1.2A	1.2A	1.2A	1.2A	
	DC13 duty (Q600)	125V	1.1A	1.1A	1.1A	1.1A	
		250V	0.55A	0.55A	0.55A	0.55A	
		400V	0.31A	0.31A	0.31A	0.31A	
		500V	0.27A	0.27A	0.27A	0.27A	
		600V	0.2A	0.2A	0.2A	0.2A	
Rated	1s	100A	-	-	100A	-	
Short-time	0.5s	125A	-	-	120A	-	
withstand current	0.1s	145A	-	-	140A	-	
Electrical lifetime (mil. operations)							
	AC15 duty	220V	0.25	0.25	0.25	0.25	1
		440V	0.25	0.25	0.25	0.25	
	DC13 duty	220V	0.25	0.25	0.25	0.25	
		440V	0.25	0.25	0.25	0.25	
Maximum operating cycles per hour		1800	1800	1800	1800	1200	
Conductor size (Solid, stranded)	AWG	18~10	18~10	18~10	18~10	18~10	
(the max. number of conducts: 2)	mm ²	1~2.5	1~2.5	1~2.5	1~2.5	1~2.5	

Installation

UA-1

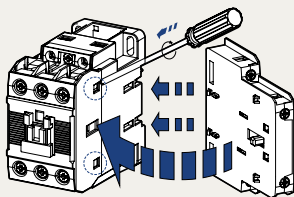

To install side mounting unit remove the indicated part in the circle in the fig. first. And then fit each part as shown. To separate push forward and pull.

UA-2, 4

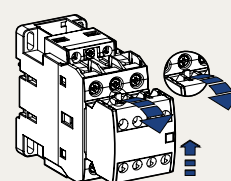

To install front mounting unit fit it on the upper part of the front of the contactor and push it down. To separate pull the lever of the unit and push the unit upward.

Mechanical latch unit ML, AL

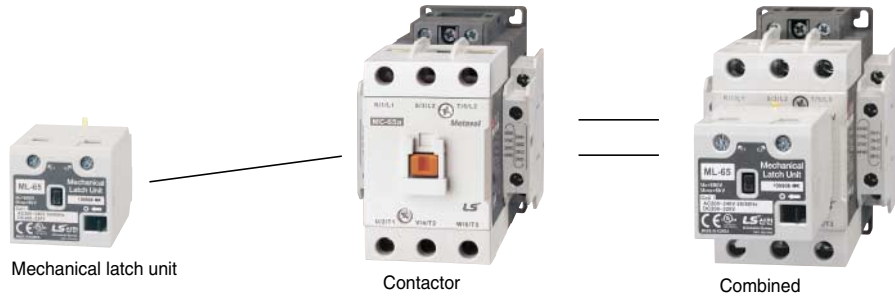

Mechanical latch unit

Contactor

Combined

Ratings



ML-65

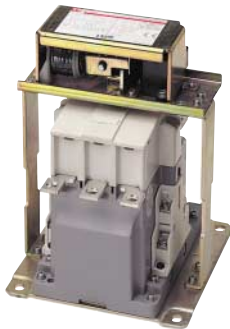

Applying contactors	Type	Coil voltage of latch unit	
MC-6a/L MC-9a/L MC-12a/L MC-18a/L MC-9b/L MC-12b/L MC-18b/L MC-22b/L MC-32a/L MC-40a/L MC-50a/L MC-65a/L	ML-65	Ordering voltage	Operation voltage
MC-75a/L MC-85a/L MC-100a/L MC-130a/L MC-150a/L		AC 24V/ DC 24V	AC 24V 50/60Hz, DC 24V
		AC 48V/ DC 48V	AC 48V 50/60Hz, DC 48V
		AC 100V/DC 100V	AC 100~127V 50/60Hz, DC 100V~125V
		AC 200V/DC 200V	AC 200~240V 50/60Hz, DC 200V~220V
		AC 400V	AC 380V~440V 50/60Hz
		* Coils for 24, 48, 100, 200V are AC / DC common.	
MC-180a/L, 225a/L	AL-220	Ordering voltage	Operation voltage
		AC 100V	AC 100~127V 50/60Hz, DC 100~125V
MC-265a/L, 330a/L, 400a/L	AL-400	AC 200V	AC 200~240V 50/60Hz, DC 200~250V
		* For using safely the product providing DC control power, Please consider that the maximum switching frequency should be less than 150 times/hour.	

Note) Latch units for upto MC-150 are supplied separately. From MC-180 the units are assembled at factory.

To install

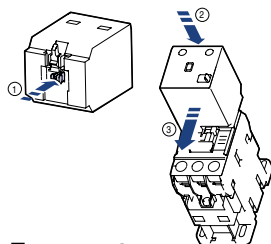

1. Push the black bar
2. Position the Latch on the top of the contactor
3. Pull in the direction of the arrow until snapping

To separate

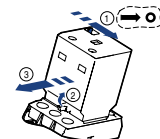

1. Pull the black lever in the direction of the arrow.
2. Pull up the yellow lever.
3. Push the latch in the direction of the arrow.

Delayed opening devices, AD

Delayed opening device prevents the inadvertent opening of a contactor in the event of a wide voltage drop or brief supply voltage interruptions of control power for 1 to 4 seconds.



Applying contactors	Type	Control voltage
MC-6a~40a, MC-9b~22b	AD-9	AC 220V
		AC 110V
MC-50a~100a	AD-50	AC 220V
		AC 110V
MC-130a~225a	AD-100	AC 100~240V
MC-265a~400a	AD-300	AC 100~240V
MC-500a~800a	AD-600	AC 100~127V
		AC 200~240V

Electronic timer unit, UT

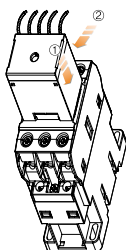

① Insult to
① way ② Push
to ② way and
assemble

Applying contactors	Type	Rated voltage	Performance	
MC-6a~150a	On delay	UT-1N	<ul style="list-style-type: none"> Mounting: Head on Contact: 1c Time delay: 1 Sec~30 Sec On delay, Off delay Frequency: AC 50/60Hz Operation: Min. voltage 85%, Max. voltage 110% Accuracy of setting time: $\pm 20\%$ 	
		UT-2N		AC/DC 24~48V
MC-9b~22b	Off delay	UT-1F		AC 110~220V
		UT-2F		AC/DC 24~48V

Terminal cover units for contactors, AP



Applying contactors	Type	Remarks
MC-185a, 225a (225AF)	AP-220	2 pcs included
MC-265a, 330a, 400a (400AF)	AP-400	
MC-500a, 630a, 800a (800AF)	AP-800	

Insulation barrier units, AI



Applying contactors	Type	Remarks
MC-185a, 225a (225AF)	AI-180	4 pcs required per contactor
MC-265a, 330a, 400a (400AF)		
MC-500a, 630a, 800a (800AF)	AI-600	

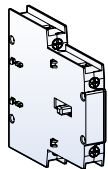

Interlock unit

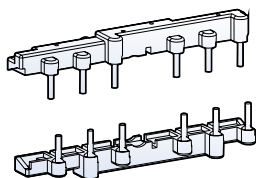

Wire kit

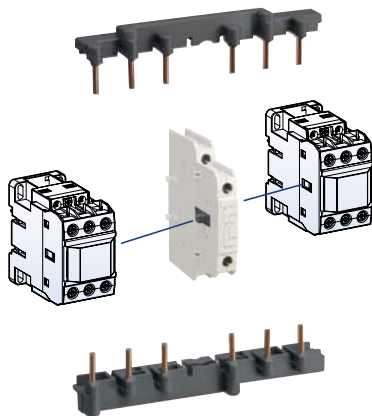

Interlocks

Component parts for assembling by customer

Interlock unit, UR-02

UR-02 is a mechanical interlock unit and provides 2NC contacts for use in electrical interlocking

Wire kit, UW

UW is used for making reversing circuit between two contactors.

Contactor	Wire kit		Interlock unit	
	Type	Weight	Type	Weight
MC-6a~18a	UW-18	0.05kg	UR-02	0.06kg
MC-9b~22b	UW-22	0.04kg		
MC-32a~40a	UW-32	0.05kg		
MC-50a, 65a	UW-63	0.12kg		
MC-75a~100a	UW-95	0.33kg		
MC-130a~150a	-	-		

Rating of the contacts in the interlocks

Rated operation voltage	600V	
Rated insulation voltage	600V	
Rated frequency	50/60Hz	
Rated thermal current	10A	
Rated operation current		
AC15 duty	120V	6A
(A600)	240V	3A
	380V	1.9A
	480V	1.5A
	500V	1.4A
	600V	1.2A
DC13 duty	125V	0.55A
	250V	0.27A

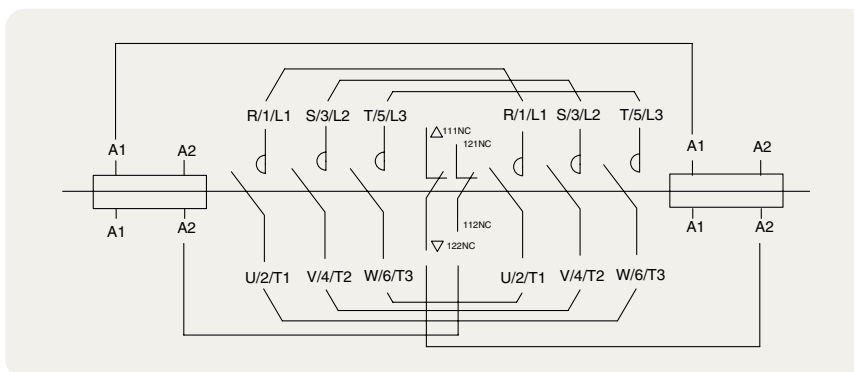

<MC-6aR ~ MC-150aR typical circuit diagram for reversing contactor>



AR-180



AR-600

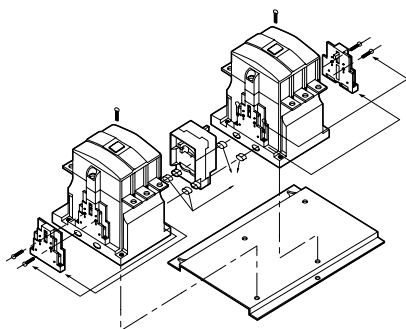

Interlock unit, AR-180 and AR-600

AR-180 and AR-600 are mechanical interlock units in which electrical contacts for use in electrical interlocking are not included. Please use the auxiliary contacts on the sides of the contactors for that purpose.

Contactor	Interlock unit	
	Type	Weight
MC-180a MC-225a MC-265a MC-330a MC-400a	AR-180	0.09kg
MC-500a MC-630a MC-800a	AR-600	15.2kg

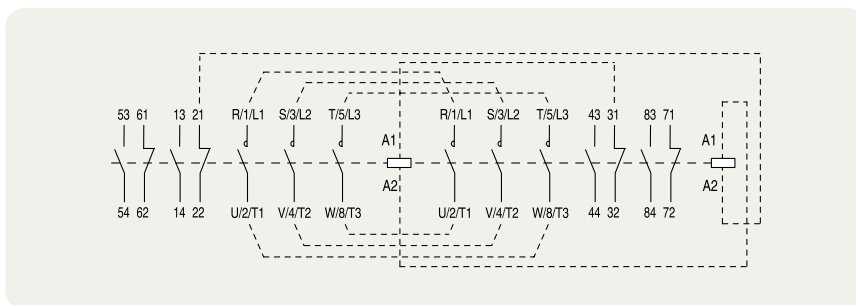

<MC-180aR ~ MC-800aR typical circuit diagram for reversing contactor>

Installation of Interlock and Wire kits

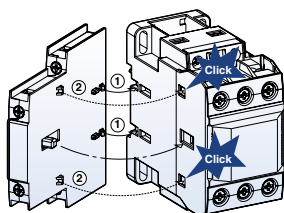

Install the interlock unit on the side of a contactor first. Fit each part as indicated in the fig.

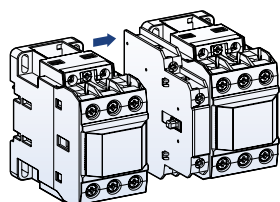

And then install the other contactor on the other side of the interlock unit as shown.

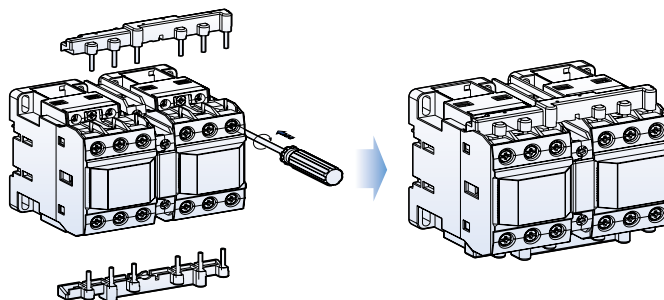

After installing interlock unit wiring kit can be assembled. Wiring kit contains two molded wires - one for line side and the other for load side.

Surge unit



US Type



AS Type

It absorbs the surge arisen out of the coil of the contactor.
It can be installed simply to the contactor.

- Rated operation voltage (Ue): AC 24 ~ 440V / DC 24 ~ 125V
- Rated insulation voltage (Ui): 1000V
- Rated impulse withstand voltage (Uimp): 8kV
- Degree of protection: IP20
- Combination with 3Pole 6a/3~150a/3, 4Pole 32a/4~85a/4

US Type

Surge unit		Rated voltage		Internal elements spec.			Contactor
Type	Composition			V	R	C	
US-1	Varistor+RC	AC	24~48V	120V	100Ω	0.1μF	3Pole MC 6a~150a 9b~22b
US-2	Varistor+RC		100~125V	270V	100Ω	0.1μF	
US-3	Varistor+RC		200~240V	470V	100Ω	0.1μF	
US-4	Varistor+RC	DC	24~48V	120V	100Ω	0.47μF	
US-5	Varistor+RC		100~125V	270V	100Ω	0.47μF	
US-6	Varistor+RC		200~220V	470V	100Ω	0.47μF	
US-11	Varistor	AC/DC common	24~48V	120V	-	-	
US-12	Varistor		100~125V	270V	-	-	
US-13	Varistor		200~240V	470V	-	-	
US-14	Varistor		380~440V	1000V	-	-	
US-22	RC	AC	100~125V	-	56Ω	1μF	

Installation (US Type)

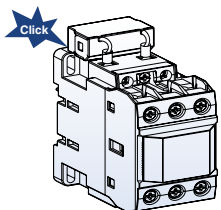
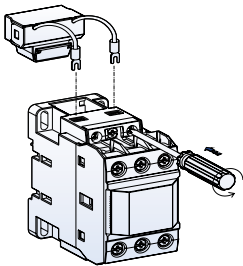

Connect the lead wires to the coil terminals of the contactor first. And then insert the body into the space of the contactor as shown above.

AS Type

Surge unit		Rated voltage		Internal elements spec.			Contactor
Type	Composition			V	R	C	
AS-1	Varistor+RC	AC	24~48V	120V	100Ω	0.1μF	3Pole MC 185a~800a 4Pole MC 22a/4~800a/4
AS-2	Varistor+RC		100~125V	270V	100Ω	0.1μF	
AS-3	Varistor+RC		200~240V	470V	100Ω	0.1μF	
AS-4	Varistor+RC	DC	24~48V	120V	100Ω	0.47μF	
AS-5	Varistor+RC		100~125V	270V	100Ω	0.47μF	
AS-6	Varistor+RC		200~220V	470V	100Ω	0.47μF	
AS-11	Varistor	AC/DC common	24~48V	120V	-	-	
AS-12	Varistor		100~125V	270V	-	-	
AS-13	Varistor		200~240V	470V	-	-	
AS-14	Varistor		AC	380~440V	1000V	-	

Specification of surge unit

Without surge unit	① With Varistor unit	② With CR+Varistor unit
Surge voltage, arise when the coil is off, may provoke mis-operation and damage in the circuit.	Varistor has an effect to cut down the peak voltage	Varistor has an effect to cut down the peak voltage and high frequency wave

Capacitor unit



Capacitor unit is connected to the terminals of the contactor to reduce the high inrush current.
IEC 60947-4-1 AC 6b

Type		AC-9 (1b)	AC-50 (1b)		
Rating thermal current (I _{th})		16A	16A		
Current	AC-15	Rated	120V	6	6
			240V	3	3
		Operational	380V	1.9	1.9
			480V	1.5	1.5
			500V	1.4	1.4
	DC-13	Rated	125V	0.55	0.55
			250V	0.27	0.27
		Operational	400V	0.15	0.15
			500V	0.13	0.13
			600V	0.1	0.1

Note) - When the switch is closed condenser must be discharged before recharged. (Maximum residual voltage at terminals $\leq 50V$)
- To prevent short current, gG type fuse must be 1.5-2 times than rated current.

Features of capacitor unit (Pre-loading resistor)

- Damping resistor that can limit the inrush current upto $60 \times I_n$ is connected to the mechanism that closed earlier than the main contact of the contactor
- No heat loss by the serial resistor
- Eliminate the switching surge
- Improving the performance of the capacitor system

Operation sequence

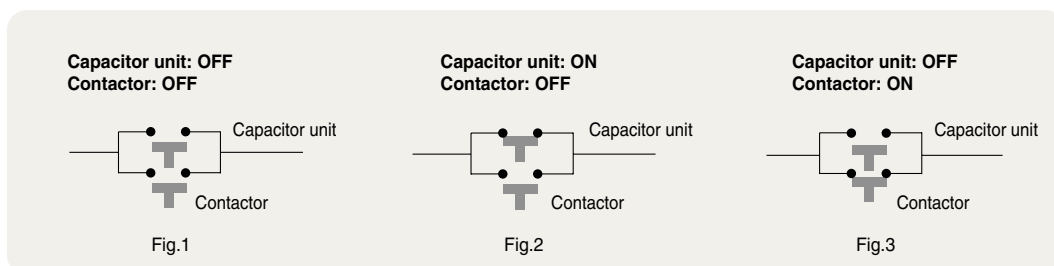

Note) Closing sequence: Fig.1 => Fig.2 => Fig.3
Opening sequence: Fig.3 => Fig.1

Replacement coils

To replace the existing coil to change voltage or repair.

Contactor	Coil voltage							
	AC coil						DC coil	
	AC 60Hz (V)		AC 50Hz (V)		AC 50/60Hz (V)		DC (V)	
MC-6a MC-9a MC-12a MC-18a MR-4, 6, 8	24	230	24	230	24	240		
	48	240	36	240	48	380		
	100	277	42	380	100	415		
	110	380	48	400	110	440		
	120	440	80	415	120	500		
	200	480	100	440	200	550		
MC-9b MC-12b MC-18b MC-22b	208	600	110	500	220			
	220		220	550	230			
	24	230	24	230	24	240		
	48	240	36	240	48	380		
	100	277	42	380	100	415		
	110	380	48	400	110	440		
MC-32a MC-40a	120	440	80	415	120	500	12	110
	200	480	100	440	200	550	20	125
	208	600	110	500	220		24	200
	220		220	550	230		48	220
	24	230	24	230	24	240	60	250
	48	240	36	240	48	380	80	
MC-50a MC-65a	100	277	42	380	100	415	100	
	110	380	48	400	110	440		
	120	440	80	415	120	500		
	200	480	100	440	200	550		
	208	600	110	500	220			
	220		220	550	230			
MC-75a MC-85a MC-100a	24	230	24	230	24	240	12	110
	48	240	36	240	48	380	20	125
	100	277	42	380	100	415	24	200
	110	380	48	400	110	440	48	220
	120	440	80	415	120	500	60	250
	200	480	100	440	200	550	80	
MC-130a MC-150a	208	600	110	500	220			
	220		220	550	230			
					24	220~240	24	110
					48	300	48	220
				100~240	400~440	70~110		
				110~120	500	100~220		



Replacement process

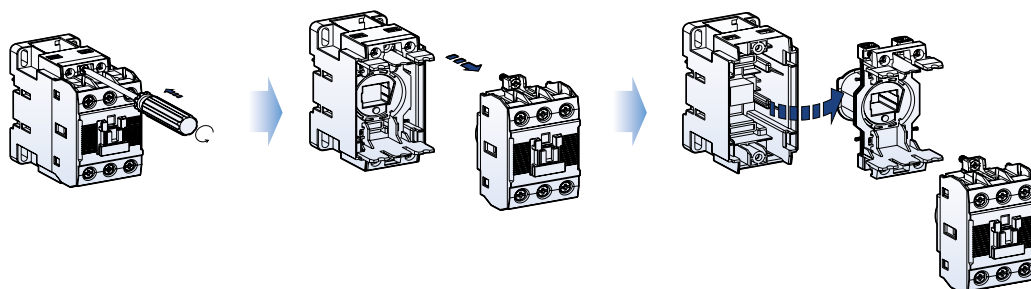

To replace the existing coil to change voltage or repair.



Contactor	Coil voltage	
	AC/DC common coil (V)	AC coil (V)
MC-185a MC-225a	24 48 100~240/100~220	300 400 500
MC-265a MC-300a MC-400a	100~240/100~220	300 400 500
MC-500a MC-630a MC-800a	100/100 200/200	300 400 500

Safety cover (Option)

- To prevent arc from coming out from the contactor
- To protect from unintended manual operation
- To prevent dust from entering into the inside of the contactor



Type	Contactor
AP-9	MC-6a~150a
AP-185	MC-185a~800a

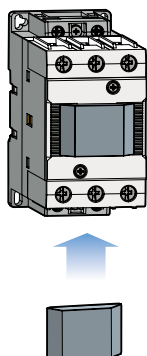

General descriptions

Type MT, bimetal-style, overload relays are designed to protect AC circuits and motors against overloads, phase failure, long starting times and prolonged stalling of the motor.

Four versions are available according to the protection function and trip class as below.

1. Non-differential: 3pole-2bimetal(heater) and trip class 10A
2. Non-differential: 3pole-3bimetal(heater) and trip class 10A
3. Differential: 3pole-3bimetal(heater) and trip class 10A
4. Differential: 3pole-3bimetal(heater) and trip class 20

Configuration of the front

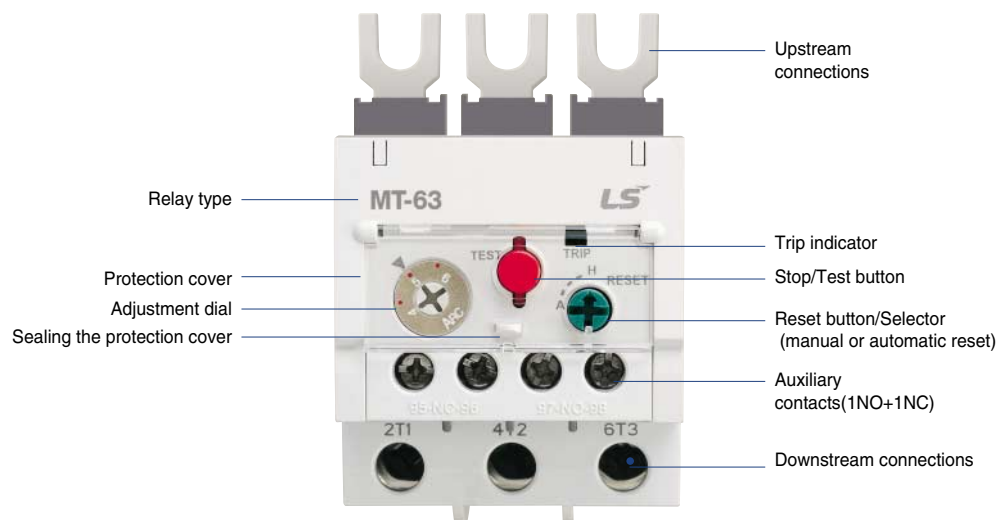

MT-12

MT-32

MT-63

MT-95



Environment and auxiliary circuit

Environment			MT-12~800
Standards			IEC/EN 60947-1, IEC/EN 60947-4-1
Certifications			CE, CSA, UL, CCC
Rated operation voltage			Max. 690V
Rated insulation voltage			690V
Rated frequency			50/60Hz
Degree of protection (Conforming to IEC 60 529)			IP 20
Ambient air temperature	Storage		-30 ~ +65° C
	Operation		-5 ~ +55° C (AC Type), -5 ~ +40° C (MT, DC Type), -25 ~ +60° C (MT refer to Graph)
Mounting position			Vertical plane
Shock resistance (Conforming to IEC 68-2-7)			15gn - 11ms
Vibration resistance (Conforming to IEC68-2-6)			6G
Insulation strength (Conforming to IEC 255-5)			6kV
Rated impulse withstand voltage (Conforming to IEC 801-5)			6kV
Auxiliary contacts characteristics			
Composition			1NO +1NC
Rated thermal current			5A
Rated operation current			C600, R300
AC15 duty (C600)	120V		1.5A
	240V		0.75A
	380V		0.47A
	480V		0.375A
	500V		0.35A
	600V		0.3A
DC13 duty (R300)	120V		0.22A
	240V		0.1A
Connecting conductor	Size	18AWG /1mm ²	
Connection to screw clamp terminals	Type	65/75° C Cu-wire	

MT-150



MT-225



MT-400



MT-800



Overload relay specifications

MT type Thermal Overload Relays



Frame size		
Trip class		
Type	Non-differential(3P-2 heater)	
	Non-differential(3P-3 heater)	
	Differential type	
Terminal type		
Number of poles		
Rated operational voltage (Ue)		
Rated insulation voltage (Ui)		
Rated impulse voltage (Uimp)		
Degree of protection (IEC 60 529)		
Temperature compensation (°C)		
Functions	Trip indicating	
	Stop	
	Test	
	Manual/Automatic Reset	
Setting range(A)		
Nominal current rating	Wire size	
	mm ²	AWG
0.14	1	18
0.21		
0.33		
0.52		
0.82		
1.3		
2.1		
3.3		
5		
6.5		
7.5	1~1.5	18~16
8.5		
11	1.5~2.5	16~14
15	2.5	14~12
19	2.5~4	12~10
21.5		
27	4~6	10
30	4~10	10~8
34	6~10	10~8
42	10	8
54		
65		
74	16~25	6~4
83		
90	25~35	4~3
Applied contactors		
Separate mounting unit		

18AF	
10A	20
MT-12/2H□S	-
MT-12/3H□S	-
MT-12/3K□S	MT-12/3D□S
Screw clamp	
3	
690V	
Up to 690V	
6kV	
IP 20	
-5~+40°C	
■	
-	
■	
■	
0.1~18A	1~18A
0.1~0.16	
0.16~0.25	
0.25~0.4	
0.4~0.63	
0.63~1	
1~1.6	1~1.6
1.6~2.5	1.6~2.5
2.5~4	2.5~4
4~6	4~6
5~8	5~8
6~9	6~9
7~10	7~10
9~13	9~13
12~18	12~18
MC-6a, 9a, 12a, 18a	
UZ-12	



40AF	
10A	20
MT-32/2H□S	-
MT-32/3H□S	-
MT-32/3K□S	MT-32/3D□S
Screw clamp	
3	
690V	
Up to 690V	
6kV	
IP 20	
-5~+40°C	
■	
■	
■	
■	
0.1~40A	1~40A
0.1~0.16	
0.16~0.25	
0.25~0.4	
0.4~0.63	
0.63~1	
1~1.6	1~1.6
1.6~2.5	1.6~2.5
2.5~4	2.5~4
4~6	4~6
5~8	5~8
6~9	6~9
7~10	7~10
9~13	9~13
12~18	12~18
16~22	16~22
18~25	18~25
22~32	22~32
-	-
28~40	28~40
MC-9b, 12b, 18b, 22b, 32a, 40a	
UZ-32	

65AF	
10A	20
MT-63/2H□S/L	-
MT-63/3H□S/L	-
MT-63/3K□S/L	MT-63/3D□S/L
Screw/Lug clamp	
3	
690V	
Up to 690V	
6kV	
IP 20	
-5~+40°C	
■	
■	
■	
■	
■	
4~65A	
4~6	4~6
5~8	5~8
6~9	6~9
7~10	7~10
9~13	9~13
12~18	12~18
16~22	16~22
18~25	18~25
-	-
24~36	24~36
28~40	28~40
34~50	34~50
45~65	45~65
MC-50a, 65a	
UZ-63S/L	

100AF	
10A	20
MT-95/2H□S/L	-
MT-95/3H□S/L	-
MT-95/3K□S/L	MT-95/3D□S/L
Screw/Lug clamp	
3	
690V	
Up to 690V	
6kV	
IP 20	
-5~+40°C	
■	
■	
■	
■	
7~100A	
7~10	7~10
9~13	9~13
12~18	12~18
16~22	16~22
18~25	18~25
-	-
24~36	24~36
28~40	28~40
34~50	34~50
45~65	45~65
54~75	54~75
63~85	63~85
70~95	70~95
80~100	80~100
MC-75a, 85a, 100a	
UZ-95S/L	

Overload relay specifications

MT type Thermal Overload Relays

Metasol



Frame size		
Trip class		
Type	Non-differential(3P-2 heater)	
	Non-differential(3P-3 heater)	
	Differential type	
Terminal type		
Number of poles		
Rated operational voltage (Ue)		
Rated insulation voltage (Ui)		
Rated impulse voltage (Uimp)		
Degree of protection (IEC 60 529)		
Temperature compensation (° C)		
Functions	Trip indicating	
	Stop	
	Test	
	Manual/Automatic Reset	
Setting range(A)		
Nominal current rating	Wire size	
	mm ²	AWG
42	10	8
55	16	6
65	25	4
74	25	4
80	35	3
93	35	2
107	50	1
113	50	1
130	50	0
130	70	00
153	95	000
200	120	250
265	185	350
350	240	500
515	185 × 2n	350 × 2n
660	240 × 2n	300 × 3n
Applied contactors		
Separate mounting unit		

150AF	
10A	20
MT-150/2H□S/L	-
MT-150/3H□S/L	-
MT-150/3K□S/L	MT-150/3D□S/L
Screw/Lug clamp	
3	
690V	
690V	
6kV	
IP 20	
-5~+40°C	
■	
■	
■	
■	
34~150A	34~150A
34~50	
45~65	
54~75	
63~85	
-	
80~105	
-	
95~130	
110~150	
MC-130a, 150a	
UZ-150S/L	



225AF

10A	20
MT-225/2H□S	-
MT-225/3H□S	-
MT-225/3K□S	MT-225/3D□S

Screw clamp	
3	
690V	
690V	
6kV	
IP 20	
-5~+40°C	
■	
■	
■	
■	

65~240A	65~240A
---------	---------

65~100
-
85~125
-
-
100~160
120~185
160~240

MC-185a, 225a
-

400AF

10A	20
MT-400/2H□S	-
MT-400/3H□S	-
MT-400/3K□S	MT-400/3D□S

Screw clamp	
3	
690V	
690V	
6kV	
IP 20	
-5~+40°C	
■	
■	
■	
■	

85~400A	85~400A
---------	---------

85~125
-
-
100~160
120~185
160~240
200~330
260~400

MC-265a, 330a, 400a
-

800AF

10A	20
MT-800/2H□S	-
MT-800/3H□S	-
MT-800/3K□S	MT-800/3D□S

Screw clamp	
3	
690V	
690V	
6kV	
IP 20	
-5~+40°C	
■	
■	
■	
■	

200~800A	200~800A
----------	----------

200~300
260~400
400~600
520~800

MC-500a, 630a, 800a
-

Overload relay operation

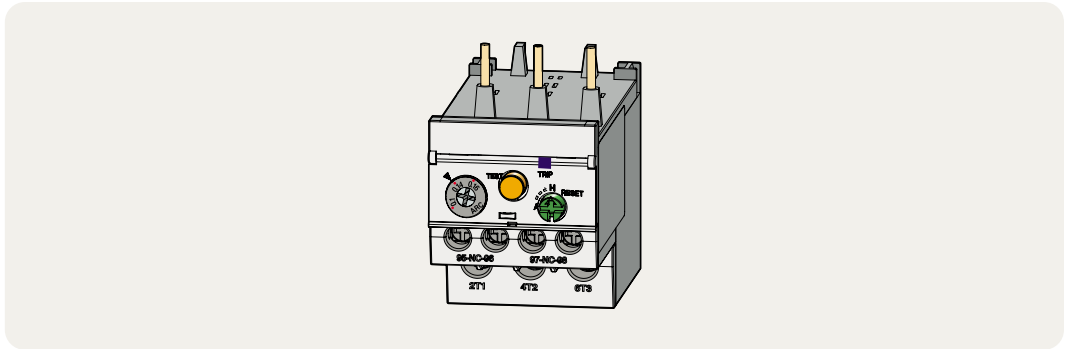
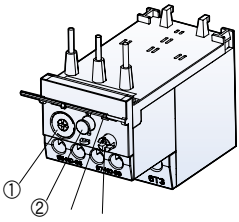

1. Adjustment dial



Before adjusting the dial open the protection cover.
Current setting can be done easily by using (+) or (-) driver.
Do not rotate the dial out of the setting range.

2. Stop/Test button

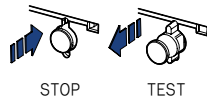

STOP function is executed by pushing the button, which causes the next sequence.
In case of operation test pull this button.

3. Trip indicator

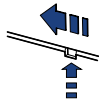

If relay is tripped it comes out.

4. Reset button/Selector

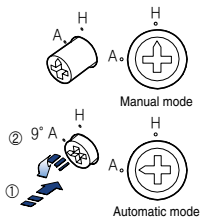

Using a driver the reset mode can be set.
In case of Manual mode(H) push the button to reset the relay.
To change to Automatic mode(A) from Manual mode push the button and rotate as shown in the fig.

5. Auxiliary contact operation

Terminal no.	Normal	STOP	TEST/TRIP	RESET
NC 95-96				
NO 97-98				

Accessories for overload relay

Separate mounting units

These accessories are used to mount the relays separately from contactors. If a relay is combined with a unit, it can be mounted on DIN rail or panel by fixing screws.



Relay	Unit	
	Type	Weight
MT-12/2H□ MT-12/3H□ MT-12/3K□ MT-12/3D□	UZ-12	35g
MT-32/2H□ MT-32/3H□ MT-32/3K□ MT-32/3D□	UZ-32	68g
MT-63/2H□ MT-63/3H□ MT-63/3K□ MT-63/3D□	UZ-63S/L	134g
MT-95/2H□ MT-95/3H□ MT-95/3K□ MT-95/3D□	UZ-95S/L	230g
MT-150/2H□ MT-150/3H□ MT-150/3K□ MT-150/3D□	UZ-150S/L	284g

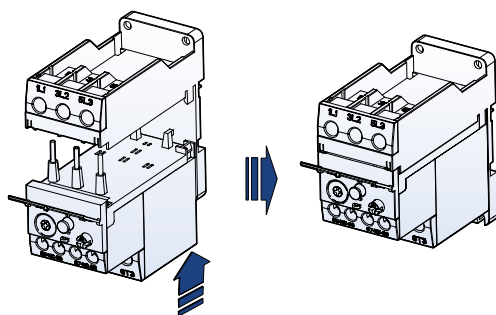

Terminal cover units for overload relays



Relay	Unit type	Remarks
MT-225	APT-225	2 pcs included
MT-400	APT-400	
MT-800	APT-600	

Accessories for overload relay

Remote reset units

These accessories are used to reset the relays on the panel door.



Type	Cable length (L)
UM-4R	400 mm
UM-5R	500 mm
UM-6R	600 mm

1. Make the reset bar straight at least 55mm from the panel door and 35mm from the bracket.
2. The bending radius of the flexible reset bar should not be less than 15mm.

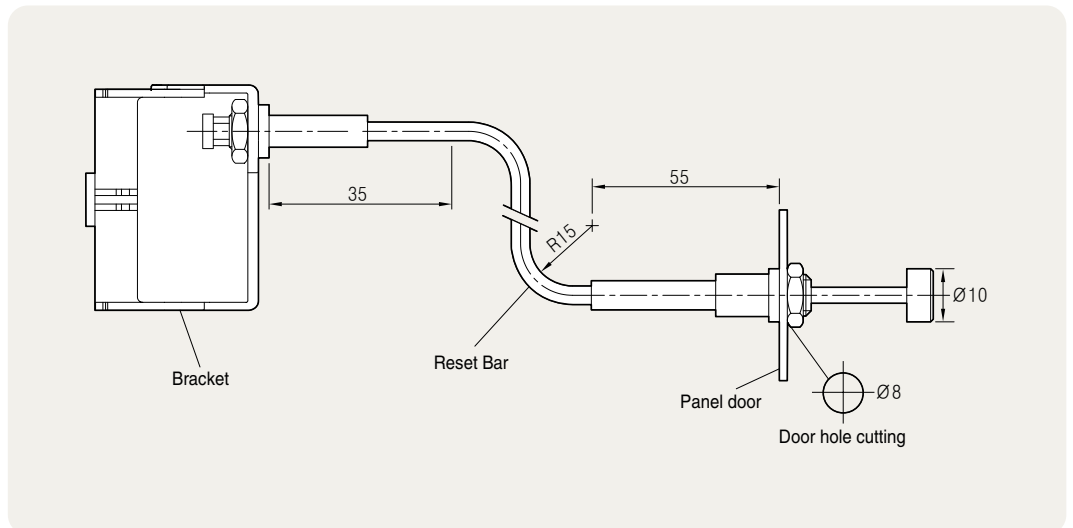

Installation

1. Fit the bracket with the relay as indicated(*1) below.
2. Separate Nut(*3) and Head cap(*4) from the reset bar first.
Insert the reset bar into the panel hole and then fix it with the Nut and Head.
3. To separate the bracket from the relay lift the *2 part as shown in the fig.

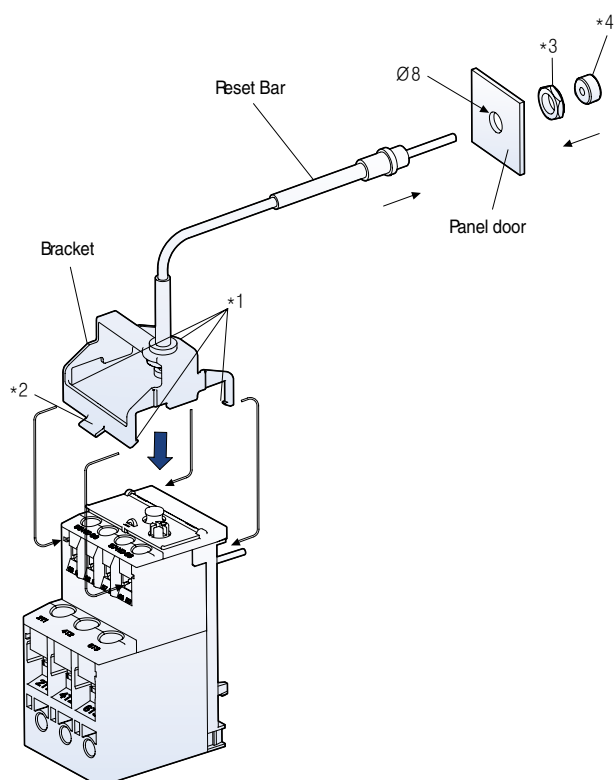
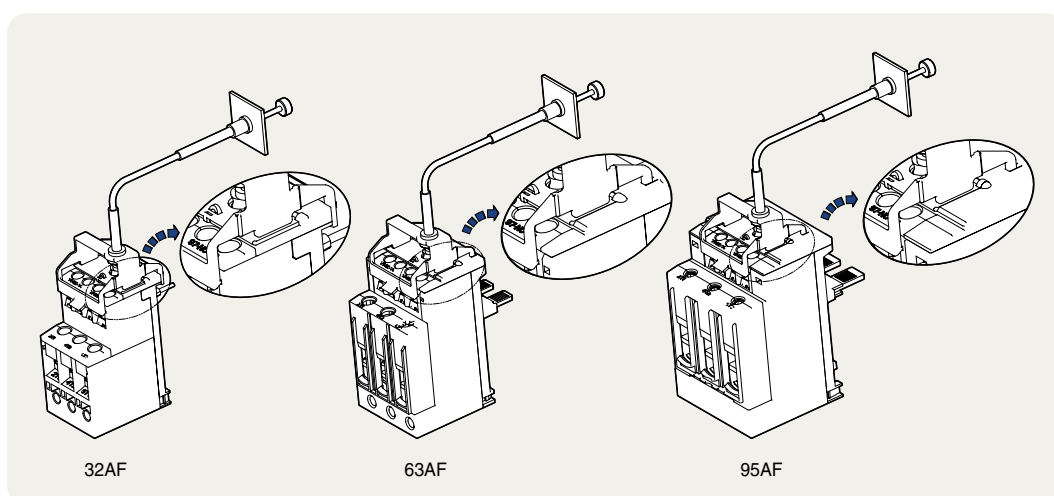

Overload relay ordering types

Trip class 10A

Terminal type: Screw

MT-12



MT-12/□

Setting range (A)	Ordering type			Contactor	Separate mounting unit
	Non-differential (3P-2 heater)	Non-differential (3P-3 heater)	Differential		
0.1~0.16	MT-12/2H0.14	MT-12/3H0.14	MT-12/3K0.14	MC-6a MC-9a MC-12a MC-18a	UZ-12
0.16~0.25	MT-12/2H0.21	MT-12/3H0.21	MT-12/3K0.21		
0.25~0.4	MT-12/2H0.33	MT-12/3H0.33	MT-12/3K0.33		
0.4~0.63	MT-12/2H0.52	MT-12/3H0.52	MT-12/3K0.52		
0.63~1	MT-12/2H0.82	MT-12/3H0.82	MT-12/3K0.82		
1~1.6	MT-12/2H1.3	MT-12/3H1.3	MT-12/3K1.3		
1.6~2.5	MT-12/2H2.1	MT-12/3H2.1	MT-12/3K2.1		
2.5~4	MT-12/2H3.3	MT-12/3H3.3	MT-12/3K3.3		
4~6	MT-12/2H5	MT-12/3H5	MT-12/3K5		
5~8	MT-12/2H6.5	MT-12/3H6.5	MT-12/3K6.5		
6~9	MT-12/2H7.5	MT-12/3H7.5	MT-12/3K7.5		
7~10	MT-12/2H8.5	MT-12/3H8.5	MT-12/3K8.5		
9~13	MT-12/2H11	MT-12/3H11	MT-12/3K11		
12~18	MT-12/2H15	MT-12/3H15	MT-12/3K15		

MT-32



MT-32/□

Setting range (A)	Ordering type			Contactor	Separate mounting unit
	Non-differential (3P-2 heater)	Non-differential (3P-3 heater)	Differential		
0.1~0.16	MT-32/2H0.14	MT-32/3H0.14	MT-32/3K0.14	MC-9b MC-12b MC-18b MC-22b MC-32a MC-40a	UZ-32
0.16~0.25	MT-32/2H0.21	MT-32/3H0.21	MT-32/3K0.21		
0.25~0.4	MT-32/2H0.33	MT-32/3H0.33	MT-32/3K0.33		
0.4~0.63	MT-32/2H0.52	MT-32/3H0.52	MT-32/3K0.52		
0.63~1	MT-32/2H0.82	MT-32/3H0.82	MT-32/3K0.82		
1~1.6	MT-32/2H1.3	MT-32/3H1.3	MT-32/3K1.3		
1.6~2.5	MT-32/2H2.1	MT-32/3H2.1	MT-32/3K2.1		
2.5~4	MT-32/2H3.3	MT-32/3H3.3	MT-32/3K3.3		
4~6	MT-32/2H5	MT-32/3H5	MT-32/3K5		
5~8	MT-32/2H6.5	MT-32/3H6.5	MT-32/3K6.5		
6~9	MT-32/2H7.5	MT-32/3H7.5	MT-32/3K7.5		
7~10	MT-32/2H8.5	MT-32/3H8.5	MT-32/3K8.5		
9~13	MT-32/2H11	MT-32/3H11	MT-32/3K11		
12~18	MT-32/2H15	MT-32/3H15	MT-32/3K15		
16~22	MT-32/2H19	MT-32/3H19	MT-32/3K19		
18~25	MT-32/2H21.5	MT-32/3H21.5	MT-32/3K21.5		
22~32	MT-32/2H27	MT-32/3H27	MT-32/3K27		
28~40	MT-32/2H34	MT-32/3H34	MT-32/3K34		

Trip class 10A

Terminal type: Screw(S), Lug(L)

MT-63



MT-63/□S



MT-63/□L

Setting range (A)	Ordering type			Contactor	Separate mounting unit
	Non-differential (3P-2 heater)	Non-differential (3P-3 heater)	Differential		
4~6	MT-63/2H5S/L	MT-63/3H5S/L	MT-63/3K5S/L	MC-50a MC-65a	UZ-63S/L
5~8	MT-63/2H6.5S/L	MT-63/3H6.5S/L	MT-63/3K6.5S/L		
6~9	MT-63/2H7.5S/L	MT-63/3H7.5S/L	MT-63/3K7.5S/L		
7~10	MT-63/2H8.5S/L	MT-63/3H8.5S/L	MT-63/3K8.5S/L		
9~13	MT-63/2H11S/L	MT-63/3H11S/L	MT-63/3K11S/L		
12~18	MT-63/2H15S/L	MT-63/3H15S/L	MT-63/3K15S/L		
16~22	MT-63/2H19S/L	MT-63/3H19S/L	MT-63/3K19S/L		
18~25	MT-63/2H21.5S/L	MT-63/3H21.5S/L	MT-63/3K21.5S/L		
24~36	MT-63/2H30S/L	MT-63/3H30S/L	MT-63/3K30S/L		
28~40	MT-63/2H34S/L	MT-63/3H34S/L	MT-63/3K34S/L		
34~50	MT-63/2H42S/L	MT-63/3H42S/L	MT-63/3K42S/L		
45~65	MT-63/2H55S/L	MT-63/3H55S/L	MT-63/3K55S/L		

MT-95



MT-95/□S



MT-95/□L

Setting range (A)	Ordering type			Contactor	Separate mounting unit
	Non-differential (3P-2 heater)	Non-differential (3P-3 heater)	Differential		
7~10	MT-95/2H8.5S/L	MT-95/3H8.5S/L	MT-95/3K8.5S/L	MC-75a MC-85a MC-100a	UZ-95S/L
9~13	MT-95/2H11S/L	MT-95/3H11S/L	MT-95/3K11S/L		
12~18	MT-95/2H15S/L	MT-95/3H15S/L	MT-95/3K15S/L		
16~22	MT-95/2H19S/L	MT-95/3H19S/L	MT-95/3K19S/L		
18~25	MT-95/2H21.5S/L	MT-95/3H21.5S/L	MT-95/3K21.5S/L		
24~36	MT-95/2H30S/L	MT-95/3H30S/L	MT-95/3K30S/L		
28~40	MT-95/2H34S/L	MT-95/3H34S/L	MT-95/3K34S/L		
34~50	MT-95/2H42S/L	MT-95/3H42S/L	MT-95/3K42S/L		
45~65	MT-95/2H55S/L	MT-95/3H55S/L	MT-95/3K55S/L		
54~75	MT-95/2H65S/L	MT-95/3H65S/L	MT-95/3K65S/L		
63~85	MT-95/2H74S/L	MT-95/3H74S/L	MT-95/3K74S/L		
70~95	MT-95/2H83S/L	MT-95/3H83S/L	MT-95/3K83S/L		
80~100	MT-95/2H90S/L	MT-95/3H90S/L	MT-95/3K90S/L		

MT-150



MT-150/□S

Setting range (A)	Ordering type			Contactor	Separate mounting unit
	Non-differential		Differential		
	(3P-2 heater)	(3P-3 heater)			
34~50	MT-150/2H42S/L	MT-150/3H42S/L	MT-150/3K42S/L	MC-130a MC-150a	UZ-150S/L
45~65	MT-150/2H55S/L	MT-150/3H55S/L	MT-150/3K55S/L		
54~75	MT-150/2H65S/L	MT-150/3H65S/L	MT-150/3K65S/L		
63~85	MT-150/2H74S/L	MT-150/3H74S/L	MT-150/3K74S/L		
80~105	MT-150/2H93S/L	MT-150/3H93S/L	MT-150/3K93S/L		
95~130	MT-150/2H113S/L	MT-150/3H113S/L	MT-150/3K113S/L		
110~150	MT-150/2H130S/L	MT-150/3H130S/L	MT-150/3K130S/L		

Overload relay ordering types

Trip class 10A

Terminal type: Screw

MT-225



MT-225 □

Setting range (A)	Ordering type			Contactor	Remarks
	Non-differential		Differential		
	(3P-2 heater)	(3P-3 heater)			
65~100	MT-225/2H80	MT-225/3H80	MT-225/3K80	MC-185a MC-225a	-
85~125	MT-225/2H107	MT-225/3H107	MT-225/3K107		
100~160	MT-225/2H130	MT-225/3H130	MT-225/3K130		
120~185	MT-225/2H153	MT-225/3H153	MT-225/3K153		
160~240	MT-225/2H200	MT-225/3H200	MT-225/3K200		

MT-400



MT-400 □

Setting range (A)	Ordering type			Contactor	Remarks
	Non-differential		Differential		
	(3P-2 heater)	(3P-3 heater)			
85~125	MT-400/2H107	MT-400/3H107	MT-400/3K107	MC-265a MC-330a MC-400a	-
100~160	MT-400/2H130	MT-400/3H130	MT-400/3K130		
120~185	MT-400/2H153	MT-400/3H153	MT-400/3K153		
160~240	MT-400/2H200	MT-400/3H200	MT-400/3K200		
200~330	MT-400/2H265	MT-400/3H265	MT-400/3K265		
260~400	MT-400/2H350	MT-400/3H350	MT-400/3K350		

MT-800



MT-800 □

Setting range (A)	Ordering type			Contactor	Remarks
	Non-differential		Differential		
	(3P-2 heater)	(3P-3 heater)			
200~330	MT-800/2H265	MT-800/3H265	MT-800/3K265	MC-500a MC-630a MC-800a	-
260~400	MT-800/2H350	MT-800/3H350	MT-800/3K350		
400~630	MT-800/2H515	MT-800/3H515	MT-800/3K515		
520~800	MT-800/2H660	MT-800/3H660	MT-800/3K660		

Trip class 20

Terminal type: Screw

MT-12

MT-12/3D□

Setting range (A)	Ordering type	Contactor	Separate mounting unit
	Differential		
1~1.6	MT-12/3D1.3	MC-6a MC-9a MC-12a MC-18a	UZ-12
1.6~2.5	MT-12/3D2.1		
2.5~4	MT-12/3D3.3		
4~6	MT-12/3D5		
5~8	MT-12/3D6.5		
6~9	MT-12/3D7.5		
7~10	MT-12/3D8.5		
9~13	MT-12/3D11		
12~18	MT-12/3D15		

MT-32

MT-32/3D□

Setting range (A)	Ordering type	Contactor	Separate mounting unit	
	Differential			
1~1.6	MT-32/3D1.3	MC-9b MC-12b MC-18b MC-22b MC-32a MC-40a	UZ-32	
1.6~2.5	MT-32/3D2.1			
2.5~4	MT-32/3D3.3			
4~6	MT-32/3D5			
5~8	MT-32/3D6.5			
6~9	MT-32/3D7.5			
7~10	MT-32/3D8.5			
9~13	MT-32/3D11			
12~18	MT-32/3D15			
16~22	MT-32/3D19			
18~25	MT-32/3D21.5			
22~32	MT-32/3D27			
28~40	MT-32/3D34			UZ-32(34A)

Overload relay ordering types

Trip class 20

Terminal type: Screw(S), Lug(L)

MT-63



MT-63/□S



MT-63/□L

Setting range (A)	Ordering type	Contactor	Separate mounting unit
	Differential		
4~6	MT-63/3D5S/L	MC-50a MC-65a	UZ-63S/L
5~8	MT-63/3D6.5S/L		
6~9	MT-63/3D7.5S/L		
7~10	MT-63/3D8.5S/L		
9~13	MT-63/3D11S/L		
12~18	MT-63/3D15S/L		
16~22	MT-63/3D19S/L		
18~25	MT-63/3D21.5S/L		
24~36	MT-63/3D30S/L		
28~40	MT-63/3D34S/L		
34~50	MT-63/3D42S/L		
45~65	MT-63/3D55S/L		

MT-95



MT-95/□S



MT-95/□L

Setting range (A)	Ordering type	Contactor	Separate mounting unit
	Differential		
7~10	MT-95/3D8.5S/L	MC-75a MC-85a MC-100a	UZ-95S/L
9~13	MT-95/3D11S/L		
12~18	MT-95/3DK15S/L		
16~22	MT-95/3D19S/L		
18~25	MT-95/3D21.5S/L		
24~36	MT-95/3D30S/L		
28~40	MT-95/3D34S/L		
34~50	MT-95/3D42S/L		
45~65	MT-95/3D55S/L		
54~75	MT-95/3D65S/L		
63~85	MT-95/3D74S/L		
70~95	MT-95/3D83S/L		
80~100	MT-95/3D90S/L		

MT-150



MT-150/□S

Setting range (A)	Ordering type	Contactor	Separate mounting unit
	Differential		
34~50	MT-150/3D42S/L	MC-130a MC-150a	UZ-150S/L
45~65	MT-150/3D55S/L		
54~75	MT-150/3D65S/L		
63~85	MT-150/3D74S/L		
80~105	MT-150/3D93S/L		
95~130	MT-150/3D113S/L		
110~150	MT-150/3D130S/L		

Trip class 20

Terminal type: Screw

MT-225

MT-225/3D□

Setting range (A)	Ordering type	Contactor	Remarks
	Differential		
65~100	MT-225/3D80	MC-185a MC-225a	-
85~125	MT-225/3D107		
100~160	MT-225/3D130		
120~185	MT-225/3D153		
160~240	MT-225/3D200		

MT-400

MT-400/3D□

Setting range (A)	Ordering type	Contactor	Remarks
	Differential		
85~125	MT-400/3D107	MC-265a MC-330a MC-400a	-
100~160	MT-400/3D130		
120~185	MT-400/3D153		
160~240	MT-400/3D200		
200~330	MT-400/3D265		
260~400	MT-400/3D350		

MT-800

MT-800/3D□

Setting range (A)	Ordering type	Contactor	Remarks
	Differential		
200~330	MT-800/3D265	MC-500a MC-630a MC-800a	-
260~400	MT-800/3D350		
400~630	MT-800/3D515		
520~800	MT-800/3D660		

Overload relay trip curves

Class 10A, 18AF

- MT-12/2H
- MT-12/3H
- MT-12/3K

Cold starting

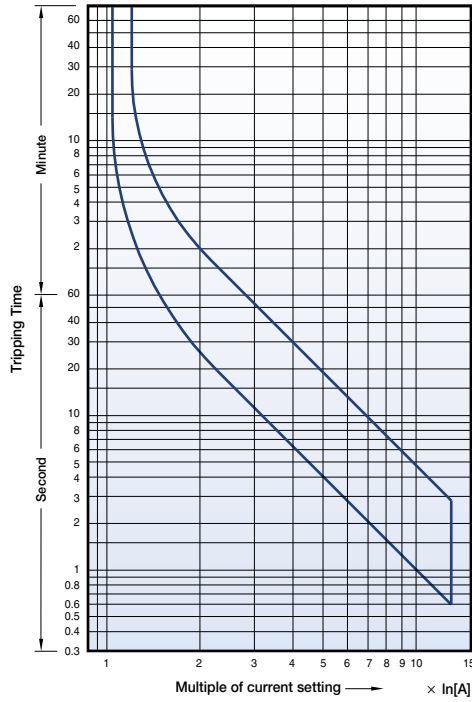

Hot starting

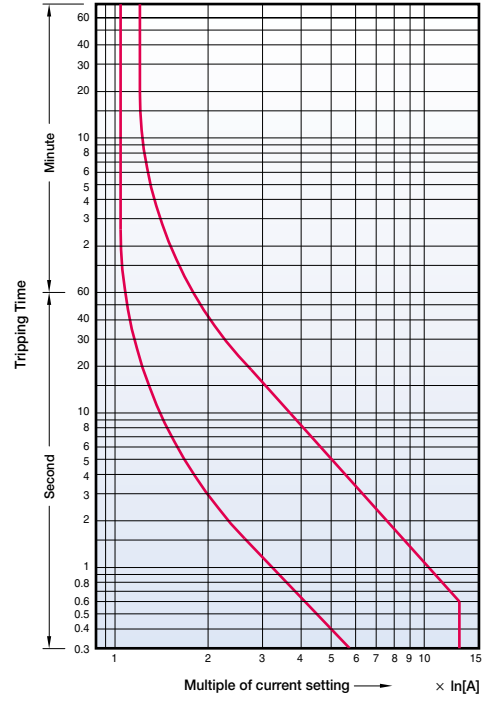

Class 20, 18AF

- MT-12/3D

Cold starting

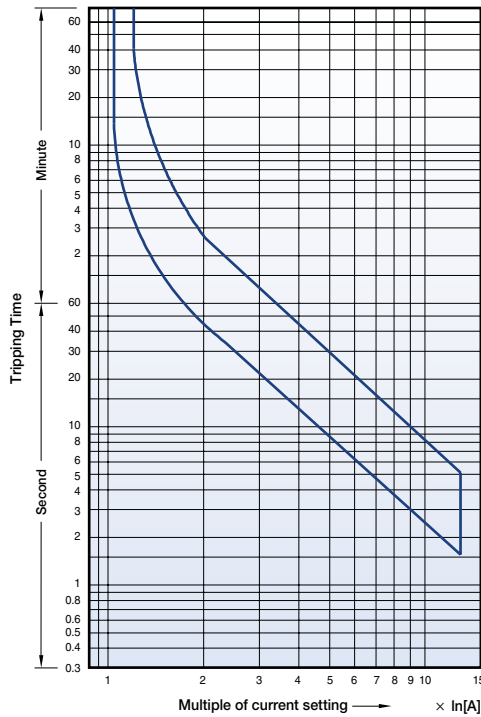

Hot starting

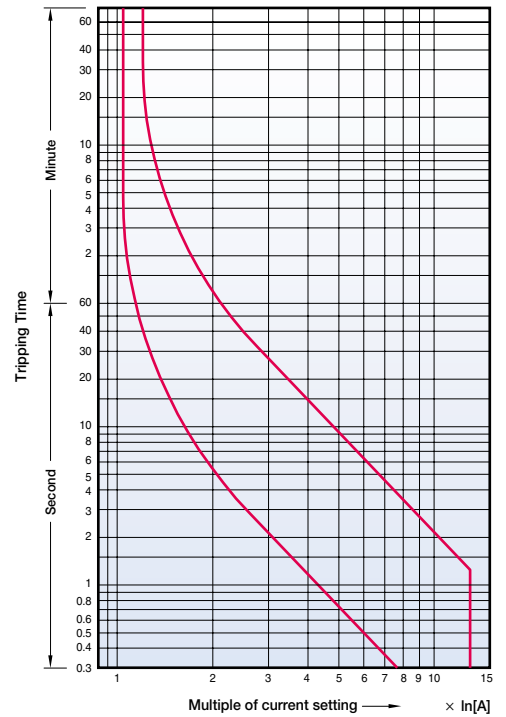

Class 10A, 40AF

- MT-32/2H
- MT-32/3H
- MT-32/3K

Cold starting

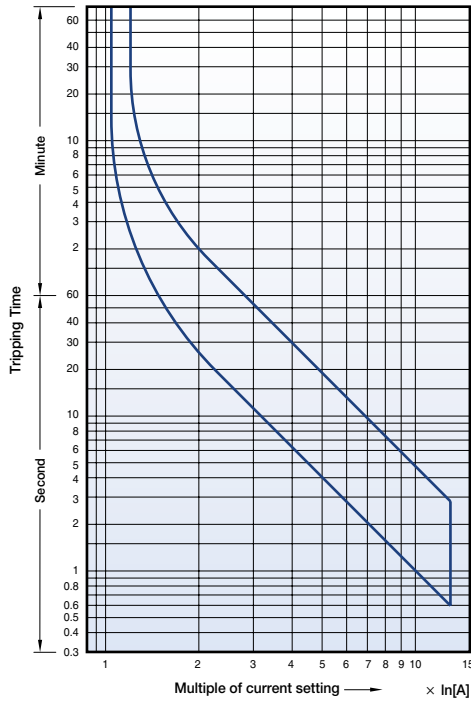

Hot starting

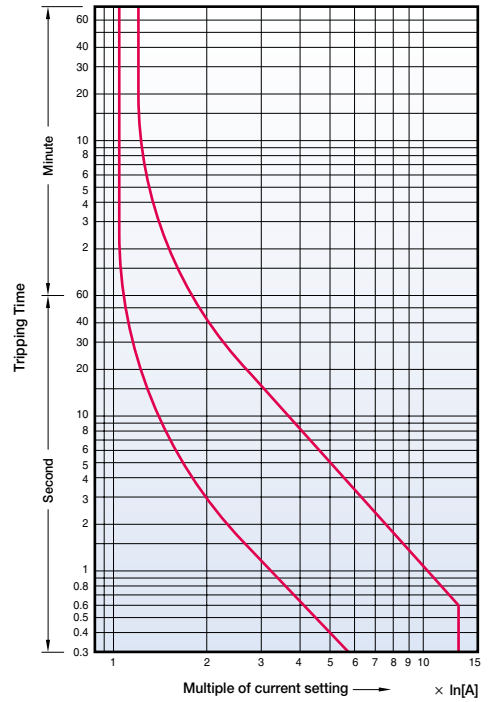

Class 20, 40AF

- MT-32/3D

Cold starting

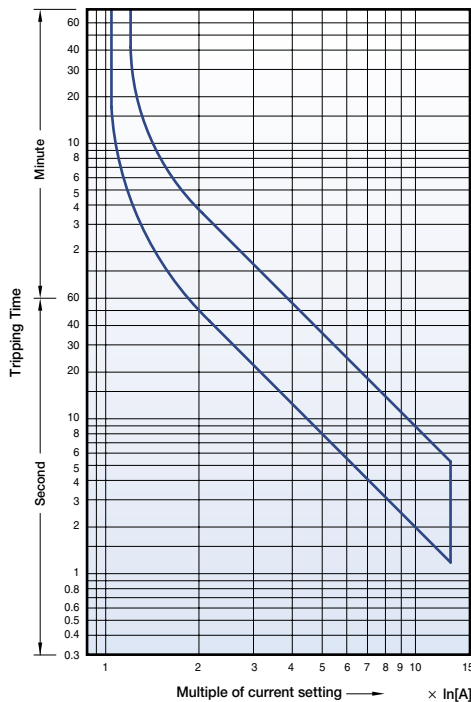

Hot starting

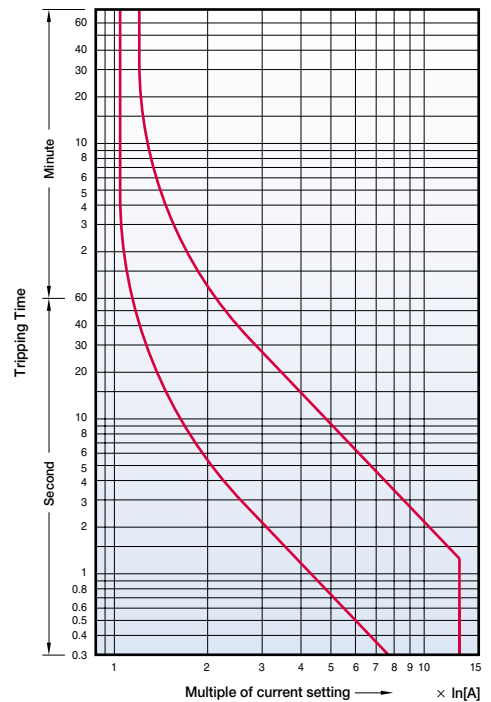

Overload relay trip curves

Metasol

Class 10A, 65AF

- MT-63/2H
- MT-63/3H
- MT-63/3K

Cold starting

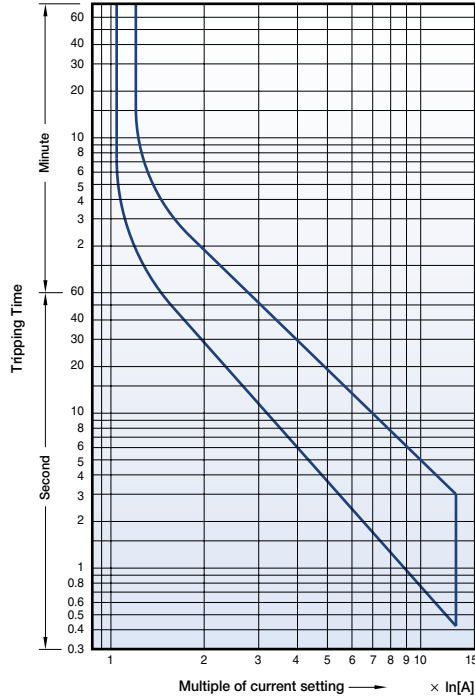

Hot starting

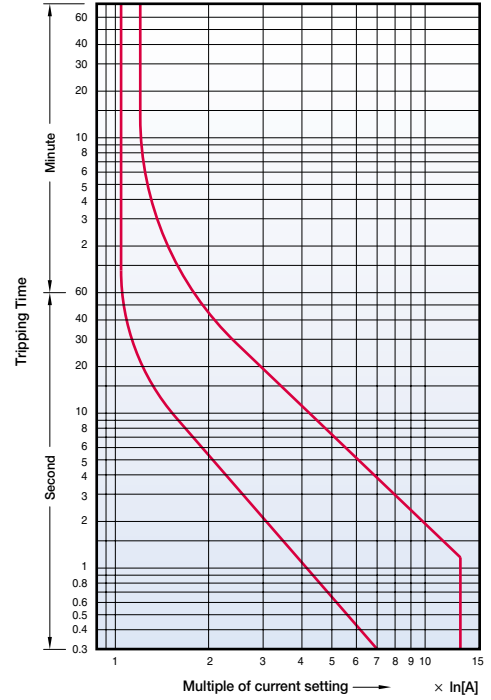

Class 20, 65AF

- MT-63/3D

Cold starting

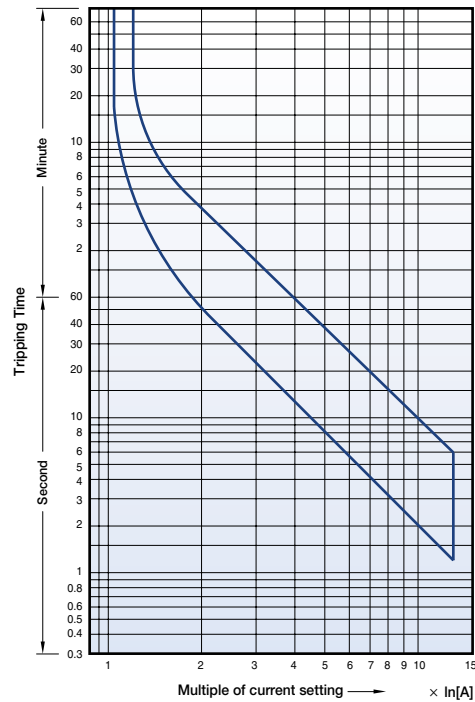

Hot starting

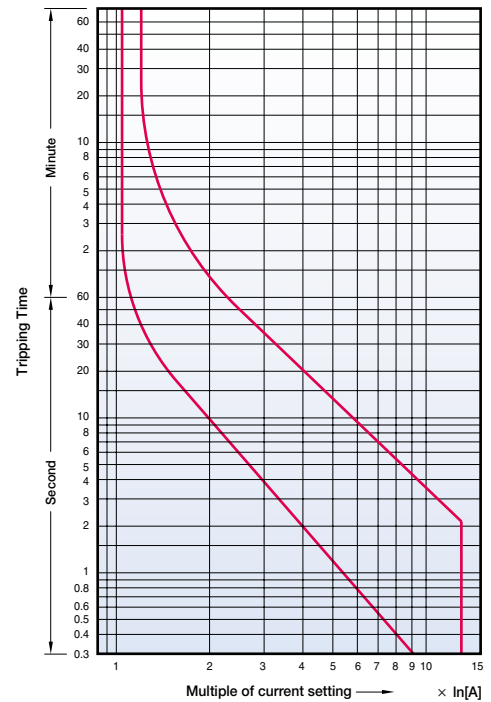

Class 10A, 100AF

- MT-95/2H
- MT-95/3H
- MT-95/3K

Cold starting

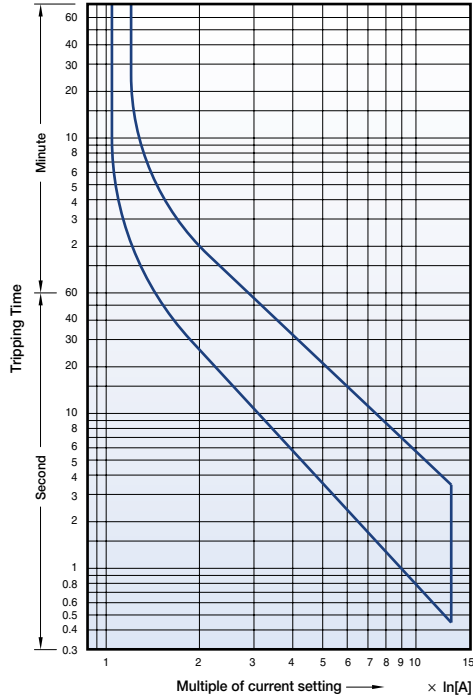

Hot starting

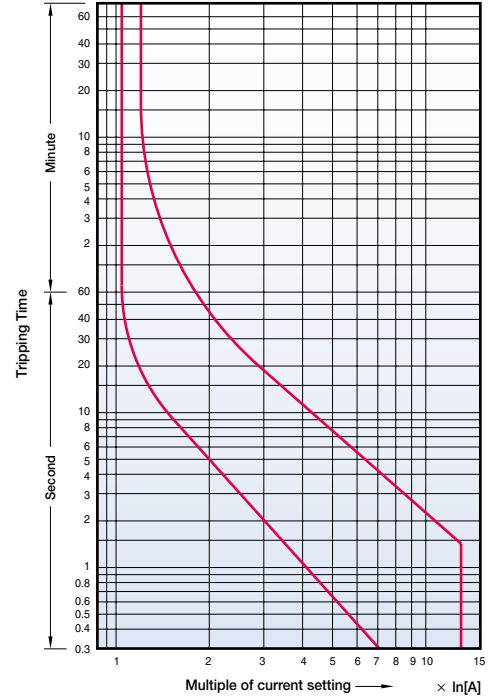

Class 20, 100AF

- MT-95/3D

Cold starting

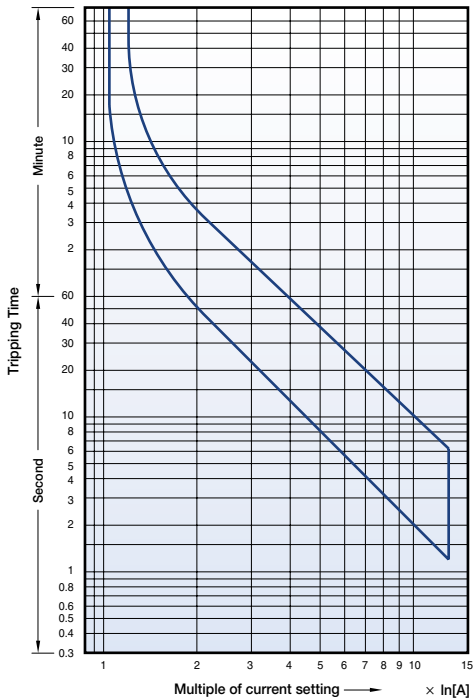

Hot starting

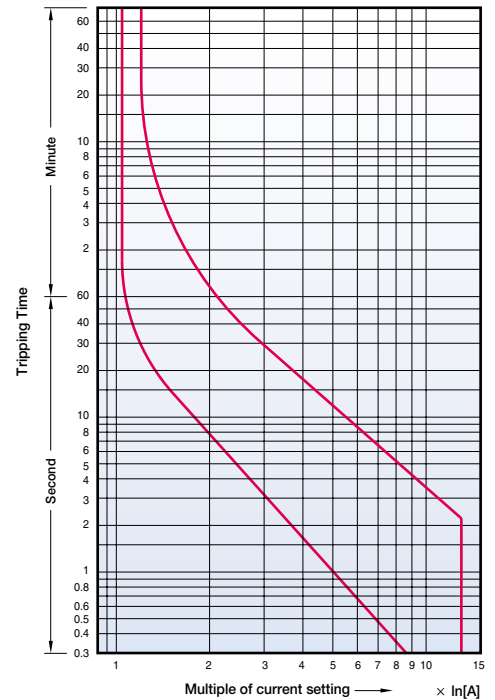

Overload relay trip curves

Metasol

Class 10A, 150AF

MT-150/2H

MT-150/3H

MT-150/3K

Cold starting

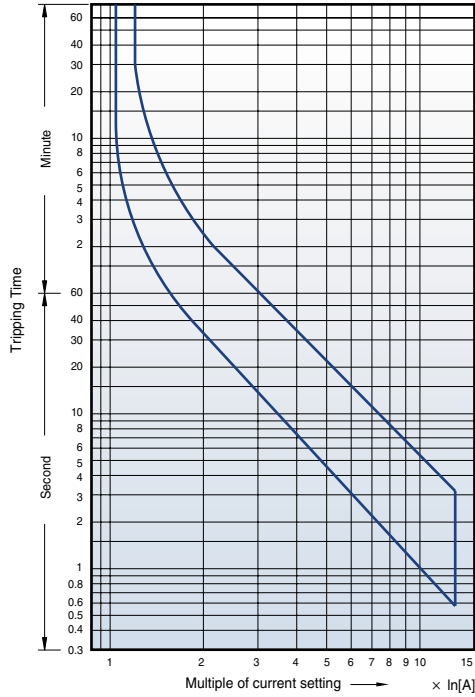

Hot starting

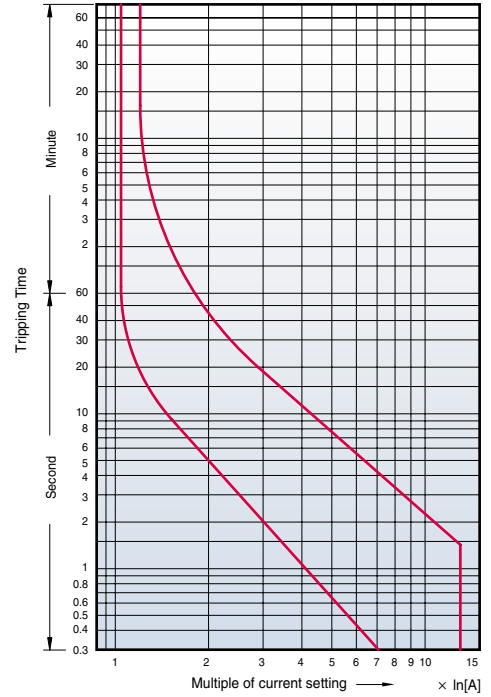

Class 20, 150AF

MT-150/3D

Cold starting

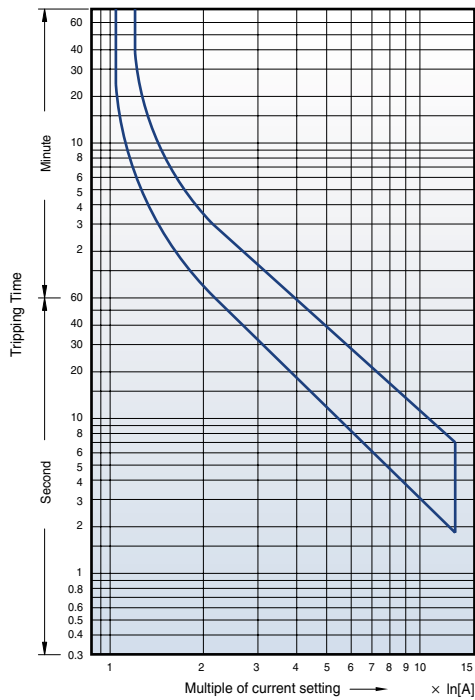

Hot starting

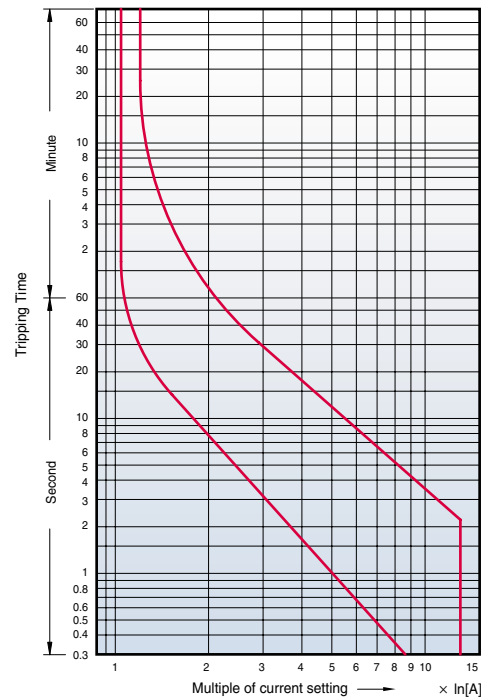

Class 10A, 225AF

- MT-225/2H
- MT-225/3H
- MT-225/3K

Cold starting

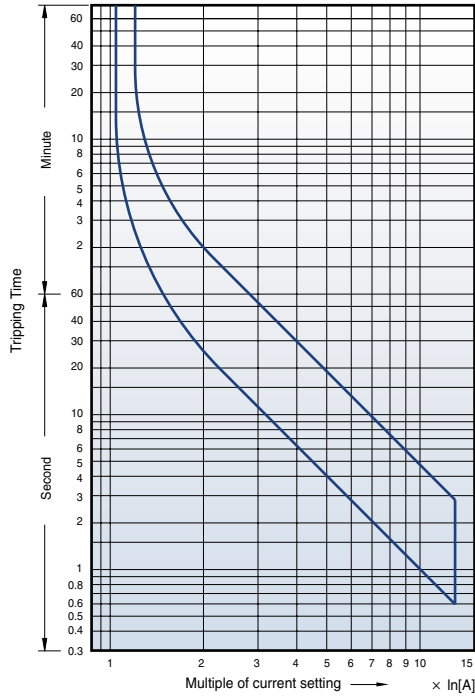

Hot starting

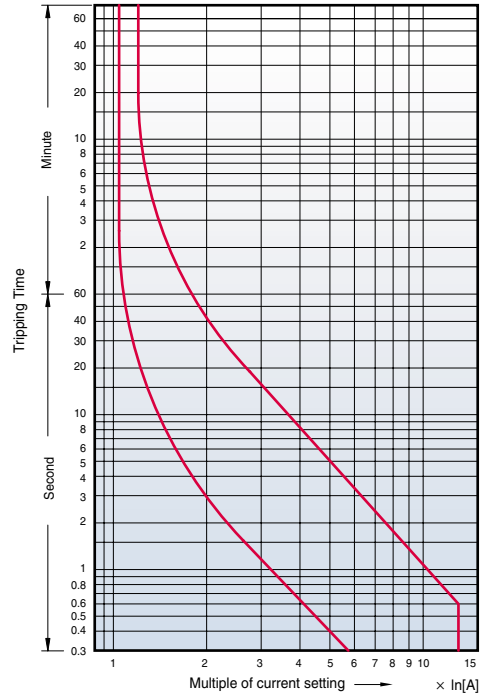

Class 20, 225AF

- MT-225/3D

Cold starting

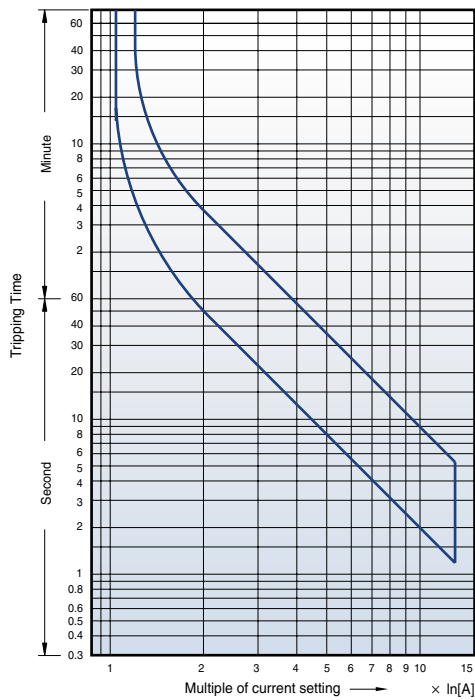

Hot starting

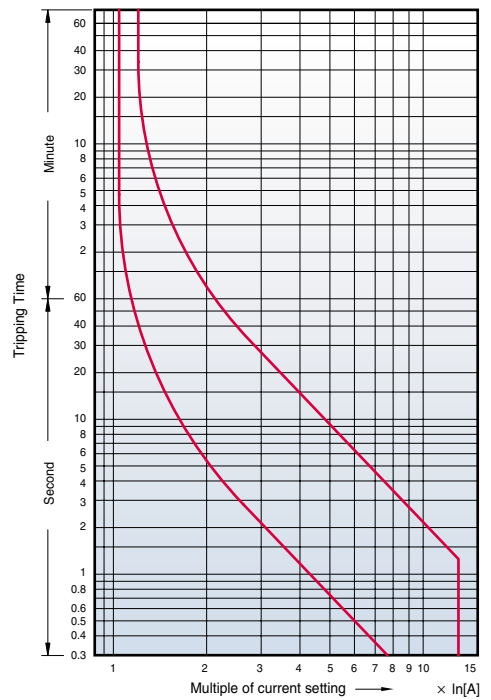

Overload relay trip curves

Metasol

Class 10A, 400AF

MT-400/2H

MT-400/3H

MT-400/3K

Cold starting

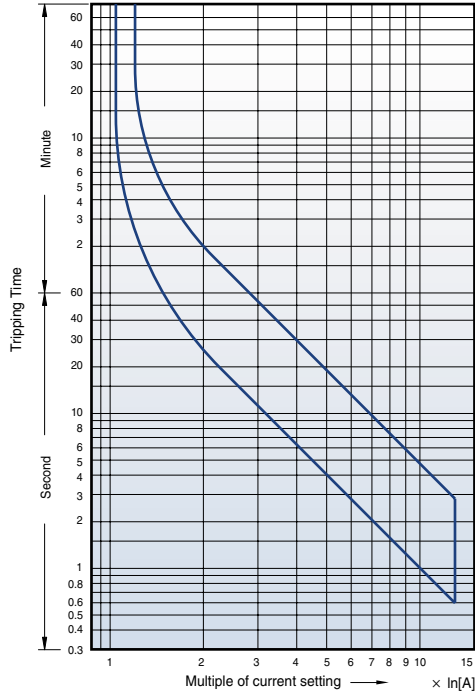

Hot starting

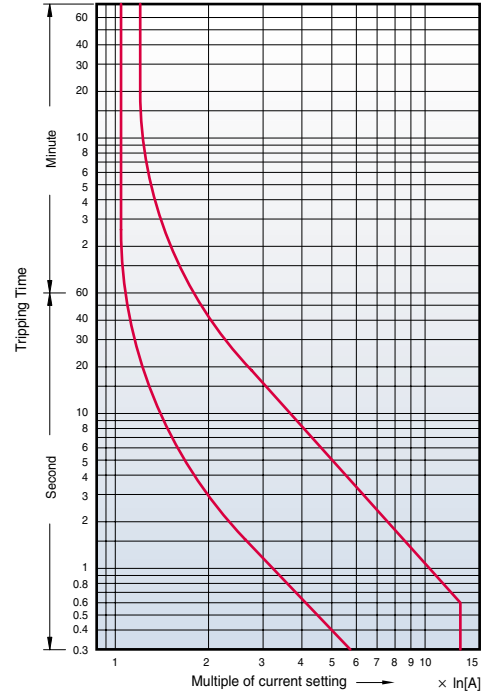

Class 20, 400AF

MT-400/3D

Cold starting

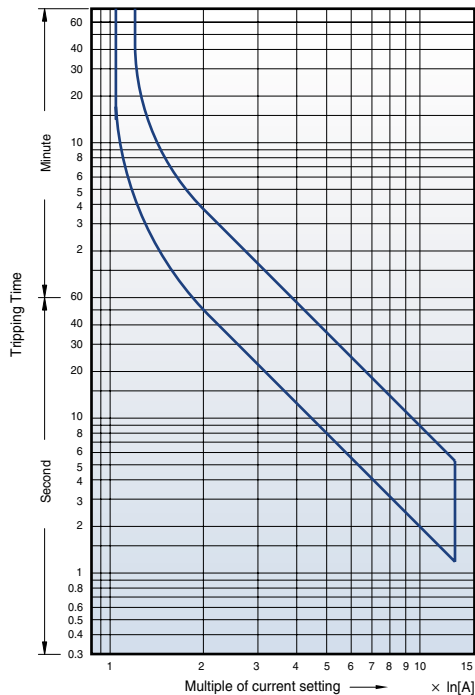

Hot starting

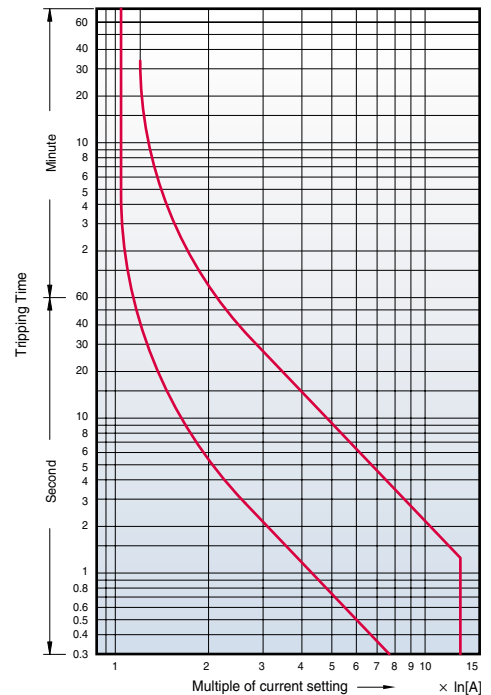

Class 10A, 800AF

- MT-800/2H
- MT-800/3H
- MT-800/3K

Cold starting

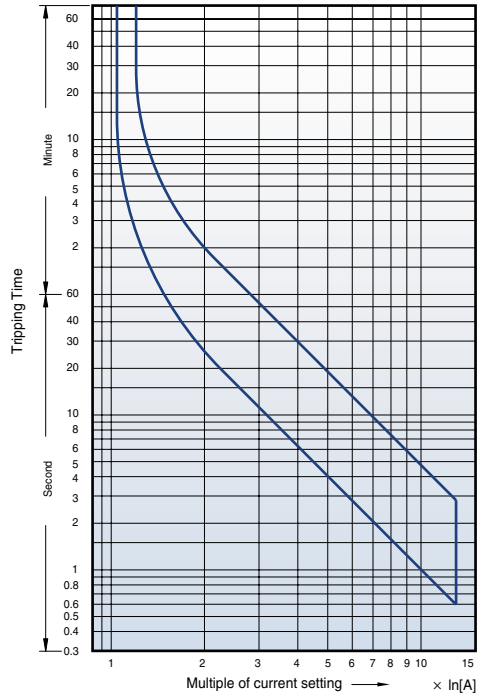

Hot starting

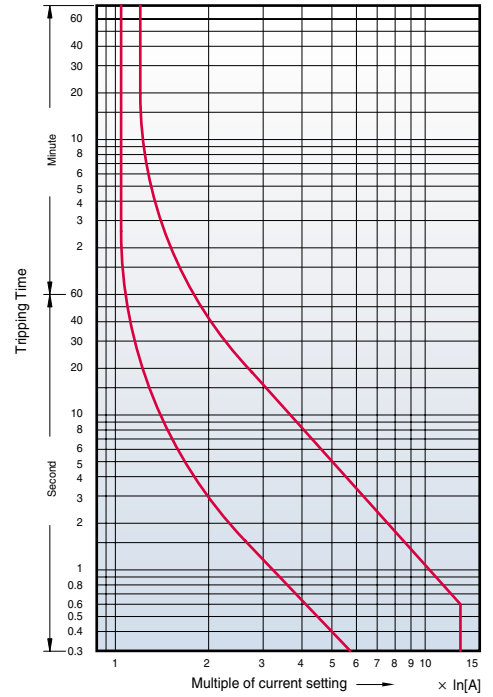

Class 20, 800AF

- MT-800/3D

Cold starting

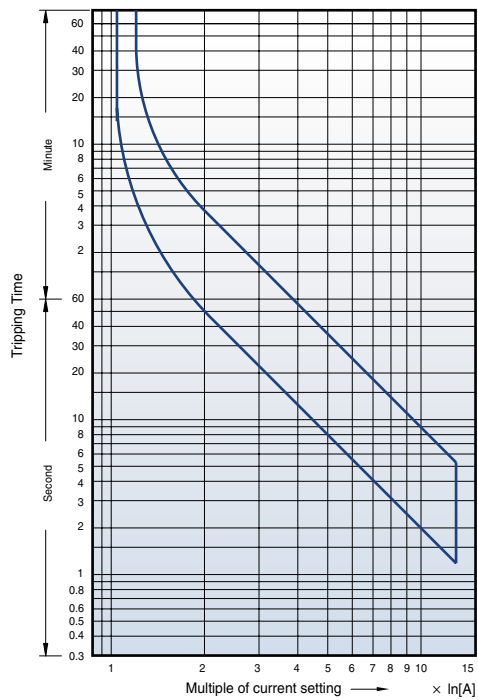

Hot starting

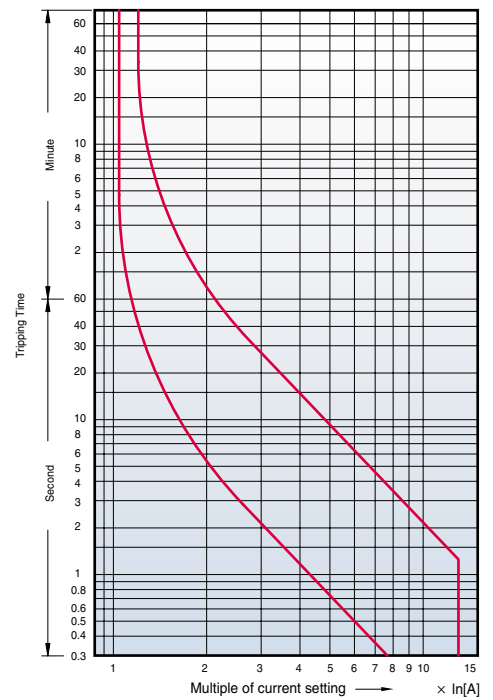

Type 2 Coordination (380/415V)

415V

HI type MMS, Susol MCCB

Rated Operational Power				Circuit Breaker		Contactor	Thermal Overload Relays		Short Circuit Breaking Capacity	
kW	Current [A]			Type	Rating [A]	Type	Type	Setting Range [A]	Ir [kA]	Iq [kA]
	380V	400V	415V							
0.06	0.21	0.20	0.19	MMS-32HI	0.25	MC-6a	MT-12	0.16~0.25	1	50
0.09	0.32	0.30	0.29	MMS-32HI	0.4	MC-6a	MT-12	0.25~0.4	1	50
0.12	0.46	0.44	0.42	MMS-32HI	0.63	MC-6a	MT-12	0.4~0.63	1	50
0.18	0.63	0.60	0.58	MMS-32HI	0.63	MC-6a	MT-12	0.4~0.63	1	50
0.25	0.89	0.85	0.82	MMS-32HI	1	MC-6a	MT-12	0.63~1	1	50
0.37	1.16	1.10	1.06	MMS-32HI	1.6	MC-12a,12b	MT-12	1~1.6	1	50
0.55	1.6	1.5	1.4	MMS-32HI	1.6	MC-12a,12b	MT-12	1~1.6	1	50
0.75	2.0	1.9	1.8	MMS-32HI	2.5	MC-12a,12b	MT-12	1.6~2.5	1	50
1.1	2.8	2.7	2.6	MMS-32HI	4	MC-22b	MT-32	2.5~4	1	50
1.5	3.8	3.6	3.5	MMS-32HI	4	MC-22b	MT-32	2.5~4	1	50
2.2	5.2	4.9	4.7	MMS-32HI	6	MC-22b	MT-32	4~6	1	50
3.0	6.8	6.5	6.3	MMS-32HI	8	MC-40a	MT-32	5~8	1	50
4.0	8.9	8.5	8.2	MMS-32HI	10	MC-40a	MT-32	6~9	1	50
5.5	12.1	11.5	11.1	MMS-32HI	13	MC-40a	MT-32	9~13	3	50
7.5	16.3	15.5	14.9	MMS-32HI	17	MC-40a	MT-32	12~18	3	50
11.0	23.2	22.0	21.2	TD100	25	MC-50a	MT-63	18~25	3	70
15.0	31	29	28	TD100	32	MC-50a	MT-63	24~36	3	70
18.5	37	35	34	TD100	40	MC-50a	MT-63	28~40	3	70
22	43	41	40	TD100	50	MC-50a	MT-63	34~50	3	70
30	58	55	53	TD100	63	MC-65a	MT-63	45~65	3	70
37	69	66	64	TD100	80	MC-75a	MT-95	54~75	5	70
45	84	80	77	TD100	100	MC-85a	MT-95	63~85	5	70
55	-	-	93	TD100	100	MC-100a	MT-95	70~95	5	70

415V

H type MMS, Susol MCCB

Rated Operational Power				Circuit Breaker		Contactor	Thermal Overload Relays		Short Circuit Breaking Capacity	
kW	Current [A]			Type	Rating [A]	Type	Type	Setting Range [A]	Ir [kA]	Iq [kA]
	380V	400V	415V							
0.06	0.21	0.20	0.19	MMS-32H	0.25	MC-6a			1	50
0.09	0.32	0.30	0.29	MMS-32H	0.4	MC-6a			1	50
0.12	0.46	0.44	0.42	MMS-32H	0.63	MC-6a			1	50
0.18	0.63	0.60	0.58	MMS-32H	0.63	MC-6a			1	50
0.25	0.89	0.85	0.82	MMS-32H	1	MC-6a			1	50
0.37	1.16	1.10	1.06	MMS-32H	1.6	MC-12a,12b			1	50
0.55	1.6	1.5	1.4	MMS-32H	1.6	MC-12a,12b			1	50
0.75	2.0	1.9	1.8	MMS-32H	2.5	MC-12a,12b			1	50
1.1	2.8	2.7	2.6	MMS-32H	4	MC-22b			1	50
1.5	3.8	3.6	3.5	MMS-32H	4	MC-22b			1	50
2.2	5.2	4.9	4.7	MMS-32H	6	MC-22b			1	50
3.0	6.8	6.5	6.3	MMS-32H	8	MC-40a			1	50
4.0	8.9	8.5	8.2	MMS-32H	10	MC-40a			1	50
5.5	12.1	11.5	11.1	MMS-32H	13	MC-40a			3	50
7.5	16.3	15.5	14.9	MMS-32H	17	MC-40a			3	50
11.0	23.2	22.0	21.2	TD100	25	MC-50a	MT-63	18-25	3	70
15.0	31	29	28	TD100	32	MC-50a	MT-63	24-36	3	70
18.5	37	35	34	TD100	40	MC-50a	MT-63	28-40	3	70
22	43	41	40	TD100	50	MC-50a	MT-63	34-50	3	70
30	58	55	53	TD100	63	MC-65a	MT-63	45-65	3	70
37	69	66	64	TD100	80	MC-75a	MT-95	54-75	5	70
45	84	80	77	TD100	100	MC-85a	MT-95	63-85	5	70
55	-	-	93	TD100	100	MC-100a	MT-95	70-95	5	70

Type 2 Coordination (380/415V)

415V

Susol MCCB

kW	Rated Operational Power			Circuit Breaker		Contactor	Thermal Overload Relays		Short Circuit Breaking Capacity	
	Current [A]			Type	Rating [A]	Type	Type	Setting Range [A]	Ir [kA]	Iq [kA]
	380V	400V	415V							
0.06	0.21	0.20	0.19	TS100 (1)	1.6	MC-6a	MT-12	0.16~0.25	1	50
0.09	0.32	0.30	0.29	TS100 (1)	1.6	MC-6a	MT-12	0.25~0.4	1	50
0.12	0.46	0.44	0.42	TS100 (1)	1.6	MC-6a	MT-12	0.4~0.63	1	50
0.18	0.63	0.60	0.58	TS100 (1)	1.6	MC-6a	MT-12	0.4~0.63	1	50
0.25	0.89	0.85	0.82	TS100 (1)	1.6	MC-6a	MT-12	0.63~1	1	50
0.37	1.16	1.10	1.06	TS100 (1)	1.6	MC-12a,12b	MT-12	1~1.6	1	50
0.55	1.6	1.5	1.4	TS100 (1)	1.6	MC-12a,12b	MT-12	1~1.6	1	50
0.75	2.0	1.9	1.8	TS100 (1)	1.6	MC-12a,12b	MT-12	1.6~2.5	1	50
1.1	2.8	2.7	2.6	TS100 (1)	3.2	MC-22b	MT-32	2.5~4	1	50
1.5	3.8	3.6	3.5	TS100 (1)	3.2	MC-22b	MT-32	2.5~4	1	50
2.2	5.2	4.9	4.7	TS100 (1)	3.2	MC-22b	MT-32	4~6	1	50
3.0	6.8	6.5	6.3	TS100 (1)	6.3	MC-40a	MT-32	5~8	1	50
4.0	8.9	8.5	8.2	TS100 (1)	6.3	MC-40a	MT-32	6~9	1	50
5.5	12.1	11.5	11.1	TS100 (1)	12	MC-40a	MT-32	9~13	3	50
7.5	16.3	15.5	14.9	TS100 (1)	12	MC-40a	MT-32	12~18	3	50
11.0	23.2	22.0	21.2	TD100	25	MC-50a	MT-63	18~25	3	70
15.0	31	29	28	TD100	32	MC-50a	MT-63	24~36	3	70
18.5	37	35	34	TD100	40	MC-50a	MT-63	28~40	3	70
22	43	41	40	TD100	50	MC-50a	MT-63	34~50	3	70
30	58	55	53	TD100	63	MC-65a	MT-63	45~65	3	70
37	69	66	64	TD100	80	MC-75a	MT-95	54~75	5	70
45	84	80	77	TD100	100	MC-85a	MT-95	63~85	5	70
55	-	-	93	TD100	100	MC-100a	MT-95	70~95	5	70

Note) (1) This marks admit for motor protection MTU trip unit only.

Type 2 Coordination (440V)

440V

Susol MCCB N-type

Rated Operational Power		Circuit Breaker		Contactor	Thermal Overload Relays		Short Circuit Breaking Capacity	
kW	Current [A]	Type	Rating [A]	Type	Type	Setting Range [A]	Ir [kA]	Iq [kA]
	400V							
1.1	2.37	TD100N	16	MC-12b	MT-32	2.5~4	1	50
1.5	3.06	TD100N	16	MC-18b	MT-32	2.5~4	1	50
2.2	4.42	TD100N	16	MC-22b	MT-32	4~6	1	50
3	5.77	TD100N	16	MC-22b	MT-32	5~8	1	50
4	7.90	TD100N	16	MC-32a	MT-32	6~9	1	50
5.5	10.40	TD100N	16	MC-32a	MT-32	9~13	3	50
7.5	13.70	TD100N	20	MC-32a	MT-32	12~18	3	50
11	20.10	TD100N	32	MC-40a	MT-32	18~25	3	50
15	26.50	TD100N	40	MC-40a	MT-32	22~32	3	50
18.5	32.80	TS100N	40	MC-50a	MT-63	28~40	3	50
22	39.00	TS100N	50	MC-50a	MT-63	34~50	3	50
30	51.50	TS100N	63	MC-65a	MT-63	45~65	3	50
37	64.00	TS100N	80	MC-75a	MT-95	54~75	5	50
45	76.00	TS100N	100	MC-85a	MT-95	63~85	5	50
55	90.00	TS100N	100	MC-100a	MT-95	70~95	5	50
59	97.00	TS160N	100	MC-130a	MT-150	80~105	5	50
75	125	TS160N	160	MC-150a	MT-150	110~150	10	50
90	146	TS160N	160	MC-185a	MT-225	120~185	10	50
110	178	TS250N	200	MC-185a	MT-225	160~240	10	50
132	215	TS250N	250	MC-225a	MT-225	160~240	10	65
160	256	TS400N	300	MC-400a	MT-400	200~330	18	65
200	330	TS400N	400	MC-400a	MT-400	260~400	18	65
220	353	TS400N	400	MC-400a	MT-400	260~400	18	65
250	401	TS630N	500	MC-630a	MT-800	260~400	18	65
300	481	TS630N	500	MC-630a	MT-800	400~630	18	65

Type 2 Coordination (440V)

440V

Susol MCCB H-type

Rated Operational Power		Circuit Breaker		Contactor	Thermal Overload Relays		Short Circuit Breaking Capacity	
kW	Current [A]	Type	Rating [A]	Type	Type	Setting Range [A]	Ir [kA]	Iq [kA]
	400V							
1.1	2.37	TD100H	16	MC-12b	MT-32	2.5~4	1	50
1.5	3.06	TD100H	16	MC-18b	MT-32	2.5~4	1	50
2.2	4.42	TD100H	16	MC-22b	MT-32	4~6	1	50
3	5.77	TD100H	16	MC-22b	MT-32	5~8	1	50
4	7.90	TD100H	16	MC-32a	MT-32	6~9	1	50
5.5	10.40	TD100H	16	MC-32a	MT-32	9~13	3	50
7.5	13.70	TD100H	20	MC-32a	MT-32	12~18	3	70
11	20.10	TD100H	32	MC-40a	MT-32	18~25	3	70
15	26.50	TD100H	40	MC-40a	MT-32	22~32	3	70
18.5	32.80	TS100H	40	MC-50a	MT-63	28~40	3	70
22	39.00	TS100H	50	MC-50a	MT-63	34~50	3	70
30	51.50	TS100H	63	MC-65a	MT-63	45~65	3	70
37	64.00	TS100H	80	MC-75a	MT-95	54~75	5	70
45	76.00	TS100H	100	MC-85a	MT-95	63~85	5	70
55	90.00	TS100H	100	MC-100a	MT-95	70~95	5	70
59	97.00	TS160H	100	MC-130a	MT-150	80~105	5	70
75	125	TS160H	160	MC-150a	MT-150	110~150	10	70
90	146	TS160H	160	MC-185a	MT-225	120~185	10	70
110	178	TS250H	200	MC-185a	MT-225	160~240	10	70
132	215	TS250H	250	MC-225a	MT-225	160~240	10	70
160	256	TS400H	300	MC-400a	MT-400	200~330	18	85
200	330	TS400H	400	MC-400a	MT-400	260~400	18	85
220	353	TS400H	400	MC-400a	MT-400	260~400	18	85
250	401	TS630H	500	MC-630a	MT-800	260~400	18	85
300	481	TS630H	500	MC-630a	MT-800	400~630	18	100

440V

Susol MCCB L-type

Rated Operational Power		Circuit Breaker		Contactor	Thermal Overload Relays		Short Circuit Breaking Capacity	
kW	Current [A]	Type	Rating [A]	Type	Type	Setting Range [A]	Ir [kA]	Iq [kA]
	400V							
1.1	2.37	TD100L	16	MC-12b	MT-32	2.5~4	1	50
1.5	3.06	TD100L	16	MC-18b	MT-32	2.5~4	1	50
2.2	4.42	TD100L	16	MC-22b	MT-32	4~6	1	50
3	5.77	TD100L	16	MC-22b	MT-32	5~8	1	50
4	7.90	TD100L	16	MC-32a	MT-32	6~9	1	50
5.5	10.40	TD100L	16	MC-32a	MT-32	9~13	3	50
7.5	13.70	TD100L	20	MC-32a	MT-32	12~18	3	100
11	20.10	TD100L	32	MC-40a	MT-32	18~25	3	100
15	26.50	TD100L	40	MC-40a	MT-32	22~32	3	100
18.5	32.80	TS100L	40	MC-50a	MT-63	28~40	3	130
22	39.00	TS100L	50	MC-50a	MT-63	34~50	3	130
30	51.50	TS100L	63	MC-65a	MT-63	45~65	3	130
37	64.00	TS100L	80	MC-75a	MT-95	54~75	5	130
45	76.00	TS100L	100	MC-85a	MT-95	63~85	5	130
55	90.00	TS100L	100	MC-100a	MT-95	70~95	5	130
59	97.00	TS160L	100	MC-130a	MT-150	80~105	5	130
75	125	TS160L	160	MC-150a	MT-150	110~150	10	130
90	146	TS160L	160	MC-185a	MT-225	120~185	10	130
110	178	TS250L	200	MC-185a	MT-225	160~240	10	130
132	215	TS250L	250	MC-225a	MT-225	160~240	10	130
160	256	TS400L	300	MC-400a	MT-400	200~330	18	130
200	330	TS400L	400	MC-400a	MT-400	260~400	18	130
220	353	TS400L	400	MC-400a	MT-400	260~400	18	130
250	401	TS630L	500	MC-630a	MT-800	260~400	18	130
300	481	TS630L	500	MC-630a	MT-800	400~630	18	130

Type 2 Coordination (440V)

440V

Metasol MCCB N-type

Rated Operational Power		Circuit Breaker		Contactor	Thermal Overload Relays		Short Circuit Breaking Capacity	
kW	Current [A]	Type	Rating [A]	Type	Type	Setting Range [A]	Ir [kA]	Iq [kA]
	400V							
1.1	2.37	ABN53c	15	MC-12b	MT-32	2.5~4	1	14
1.5	3.06	ABN53c	15	MC-18b	MT-32	2.5~4	1	14
2.2	4.42	ABN53c	15	MC-22b	MT-32	4~6	1	14
3.0	5.77	ABN53c	15	MC-22b	MT-32	5~8	1	14
4.0	7.90	ABN53c	15	MC-32a	MT-32	6~9	1	14
5.5	10.40	ABN53c	15	MC-32a	MT-32	9~13	3	14
7.5	13.70	ABN53c	20	MC-32a	MT-32	12~18	3	14
11.0	20.10	ABN103c	30	MC-40a	MT-32	18~25	3	18
15.0	26.50	ABN103c	40	MC-40a	MT-32	22~32	3	18
18.5	32.80	ABN103c	40	MC-50a	MT-63	28~40	3	18
22.0	39.00	ABN103c	50	MC-50a	MT-63	34~50	3	18
30.0	51.50	ABN103c	75	MC-65a	MT-63	45~65	3	18
37.0	64.00	ABN103c	75	MC-75a	MT-95	54~75	5	18
45.0	76.00	ABN103c	100	MC-85a	MT-95	63~85	5	18
55.0	90.00	ABN103c	100	MC-100a	MT-95	70~95	5	18
59.0	97.00	ABN103c	100	MC-130a	MT-150	80~105	5	18
75.0	125	ABN203c	150	MC-150a	MT-150	110~150	10	26
90.0	146	ABN203c	200	MC-185a	MT-225	120~185	10	26
110.0	178	ABN203c	200	MC-185a	MT-225	160~240	10	26
132.0	215	ABN203c	250	MC-225a	MT-225	160~240	10	26
160.0	256	ABN403c	300	MC-400a	MT-400	200~330	18	37
200.0	330	ABN403c	400	MC-400a	MT-400	260~400	18	37
220.0	353	ABN403c	400	MC-400a	MT-400	260~400	18	37
250.0	401	ABN803c	500	MC-630a	MT-800	260~400	18	37
300.0	481	ABN803c	500	MC-630a	MT-800	400~630	18	37

440V

Metasol MCCB S-type

Rated Operational Power		Circuit Breaker		Contactor	Thermal Overload Relays		Short Circuit Breaking Capacity	
kW	Current [A]	Type	Rating [A]	Type	Type	Setting Range [A]	Ir [kA]	Iq [kA]
	400V							
1.1	2.37	ABS53c	15	MC-12b	MT-32	2.5~4	1	18
1.5	3.06	ABS53c	15	MC-18b	MT-32	2.5~4	1	18
2.2	4.42	ABS53c	15	MC-22b	MT-32	4~6	1	18
3.0	5.77	ABS53c	15	MC-22b	MT-32	5~8	1	18
4.0	7.90	ABS53c	15	MC-32a	MT-32	6~9	1	18
5.5	10.40	ABS53c	15	MC-32a	MT-32	9~13	3	18
7.5	13.70	ABS53c	20	MC-32a	MT-32	12~18	3	18
11.0	20.10	ABS103c	30	MC-40a	MT-32	18~25	3	37
15.0	26.50	ABS103c	40	MC-40a	MT-32	22~32	3	37
18.5	32.80	ABS103c	40	MC-50a	MT-63	28~40	3	37
22.0	39.00	ABS103c	50	MC-50a	MT-63	34~50	3	37
30.0	51.50	ABS103c	75	MC-65a	MT-63	45~65	3	37
37.0	64.00	ABS103c	75	MC-75a	MT-95	54~75	5	37
45.0	76.00	ABS103c	100	MC-85a	MT-95	63~85	5	37
55.0	90.00	ABS103c	100	MC-100a	MT-95	70~95	5	37
59.0	97.00	ABS103c	100	MC-130a	MT-150	80~105	5	37
75.0	125	ABS203c	150	MC-150a	MT-150	110~150	10	37
90.0	146	ABS203c	200	MC-185a	MT-225	120~185	10	37
110.0	178	ABS203c	200	MC-185a	MT-225	160~240	10	37
132.0	215	ABS203c	250	MC-225a	MT-225	160~240	10	37
160.0	256	ABS403c	300	MC-400a	MT-400	200~330	18	50
200.0	330	ABS403c	400	MC-400a	MT-400	260~400	18	50
220.0	353	ABS403c	400	MC-400a	MT-400	260~400	18	50
250.0	401	ABS803c	500	MC-630a	MT-800	260~400	18	65
300.0	481	ABS803c	500	MC-630a	MT-800	400~630	18	65

Type 2 Coordination (440V)

440V

Metasol MCCB H-type

Rated Operational Power		Circuit Breaker		Contactor	Thermal Overload Relays		Short Circuit Breaking Capacity	
kW	Current [A]	Type	Rating [A]	Type	Type	Setting Range [A]	Ir [kA]	Iq [kA]
	400V							
1.1	2.37	ABH53c	15	MC-12b	MT-32	2.5~4	1	35
1.5	3.06	ABH53c	15	MC-18b	MT-32	2.5~4	1	35
2.2	4.42	ABH53c	15	MC-22b	MT-32	4~6	1	35
3	5.77	ABH53c	15	MC-22b	MT-32	5~8	1	35
4	7.90	ABH53c	15	MC-32a	MT-32	6~9	1	35
5.5	10.40	ABH53c	15	MC-32a	MT-32	9~13	3	35
7.5	13.70	ABH53c	20	MC-32a	MT-32	12~18	3	35
11	20.10	ABH103c	30	MC-40a	MT-32	18~25	3	50
15	26.50	ABH103c	40	MC-40a	MT-32	22~32	3	50
18.5	32.80	ABH103c	40	MC-50a	MT-63	28~40	3	50
22	39.00	ABH103c	50	MC-50a	MT-63	34~50	3	50
30	51.50	ABH103c	75	MC-65a	MT-63	45~65	3	50
37	64.00	ABH103c	75	MC-75a	MT-95	54~75	5	50
45	76.00	ABH103c	100	MC-85a	MT-95	63~85	5	50
55	90.00	ABH103c	100	MC-100a	MT-95	70~95	5	50
59	97.00	ABH103c	100	MC-130a	MT-150	80~105	5	50
75	125	ABH203c	150	MC-150a	MT-150	110~150	10	50
90	146	ABH203c	200	MC-185a	MT-225	120~185	10	50
110	178	ABH203c	200	MC-185a	MT-225	160~240	10	50
132	215	ABH203c	250	MC-225a	MT-225	160~240	10	50
160	256	ABL403c	300	MC-400a	MT-400	200~330	18	85
200	330	ABL403c	400	MC-400a	MT-400	260~400	18	85
220	353	ABL403c	400	MC-400a	MT-400	260~400	18	85
250	401	ABL803c	500	MC-630a	MT-800	260~400	18	85
300	481	ABL803c	500	MC-630a	MT-800	400~630	18	85

Rated UL 508 combination motor controller Type-C

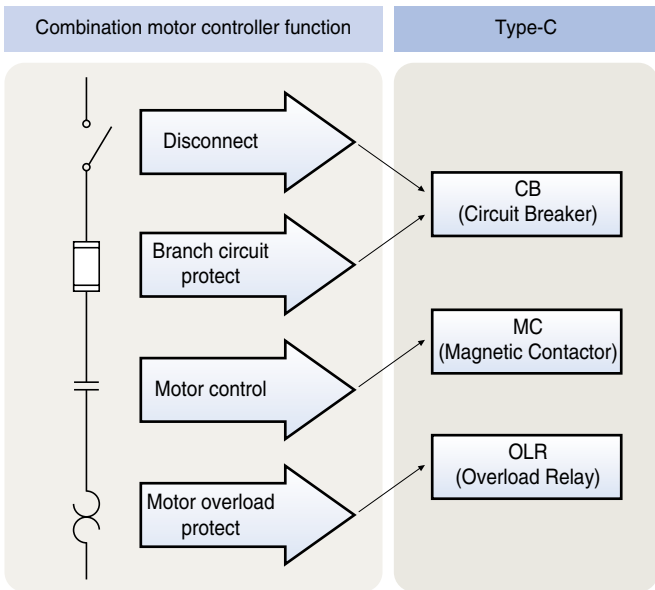

240V

CB	MC	OLR	kA@240V	Maximum HP	Maximum NEC FLC [A]
TD125HU 15A	MC-6a	MT-12 0.1~10A	100	3	9.6
TD125HU 15A	MC-9a	MT-12 0.1~10A	100	3	9.6
TD125HU 15~20A	MC-12a	MT-12 0.1~18A	100	5	15.2
TD125HU 15~20A	MC-18a	MT-12 0.1~18A	100	-	18
TD125HU 15A	MC-9b	MT-32 0.1~10A	100	3	9.6
TD125HU 15~30A	MC-12b	MT-32 0.1~18A	100	5	15.2
TD125HU 15~30A	MC-18b	MT-32 0.1~25A	100	7.5	22
TD125HU 15~40A	MC-22b	MT-32 0.1~32A	100	10	28
TD125HU 40A	MC-32a	MT-32 0.1~32A	100	10	28
TD125HU 40~50A	MC-40a	MT-32 0.1~40A	100	-	40
TD125HU 60~100A	MC-50a	MT-63 4~65A	100	-	65
TD125HU 60~100A	MC-65a	MT-63 4~65A	100	-	65
TS250HU 150A	MC-75a	MT-95 7~95A	100	30	80
TS250HU 150~200A	MC-85a	MT-95 7~100A	100	-	100
TS250HU 150~200A	MC-100a	MT-95 7~100A	100	-	100
TS250HU 250A	MC-130a	MT-150 34~130A	100	40	104
TS250HU 250A	MC-150a	MT-150 34~130A	100	50	130

Rated UL 508 combination motor controller Type-C

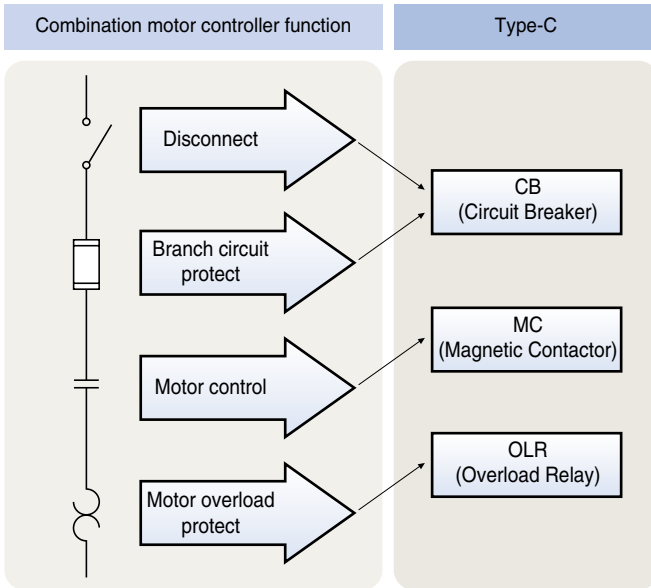

480V

CB	MC	OLR	kA@480V	Maximum HP	Maximum NEC FLC [A]
TD125HU 15A	MC-6a	MT-12 0.1~10A	65	5	7.6
TD125HU 15A	MC-9a	MT-12 0.1~10A	65	5	7.6
TD125HU 15~20A	MC-12a	MT-12 0.1~13A	65	7.5	11
TD125HU 15~20A	MC-18a	MT-12 0.1~18A	65	10	14
TD125HU 15A	MC-9b	MT-32 0.1~10A	65	5	7.6
TD125HU 15~20A	MC-12b	MT-32 0.1~13A	65	7.5	11
TD125HU 15~30A	MC-18b	MT-32 0.1~18A	65	10	14
TD125HU 15~30A	MC-22b	MT-32 0.1~25A	65	15	21
TD125HU 40A	MC-32a	MT-32 0.1~32A	65	20	27
TD125HU 40A	MC-40a	MT-32 0.1~40A	65	30	40
TD125HU 60~100A	MC-50a	MT-63 4~65A	65	40	52
TD125HU 60~100A	MC-65a	MT-63 4~65A	65	50	65
TS250HU 150A	MC-75a	MT-95 7~75A	65	50	65
TS250HU 150A	MC-85a	MT-95 7~85A	65	60	77
TS250HU 150~200A	MC-100a	MT-95 7~100A	65	75	96
TS250HU 250A	MC-130a	MT-150 34~130A	65	75	96
TS250HU 250A	MC-150a	MT-150 34~130A	65	100	124

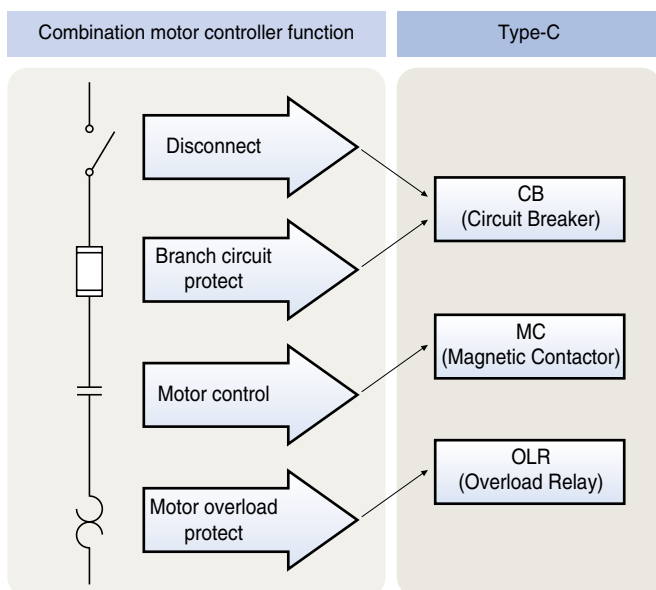

600V

CB	MC	OLR	kA@600V	Maximum HP	Maximum NEC FLC [A]
TD125HU 15A	MC-6a	MT-12 0.1~10A	14	7.5	9
TD125HU 15A	MC-9a	MT-12 0.1~10A	14	7.5	9
TD125HU 15~20A	MC-12a	MT-12 0.1~13A	14	10	11
TD125HU 15~20A	MC-18a	MT-12 0.1~18A	14	15	17
TD125HU 15A	MC-9b	MT-32 0.1~10A	14	7.5	9
TD125HU 15~20A	MC-12b	MT-32 0.1~13A	14	10	11
TD125HU 15~30A	MC-18b	MT-32 0.1~18A	14	15	17
TD125HU 15~30A	MC-22b	MT-32 0.1~25A	14	20	22
TD125HU 40A	MC-32a	MT-32 0.1~32A	14	25	27
TD125HU 40~50A	MC-40a	MT-32 0.1~40A	14	30	32
TD125HU 60~100A	MC-50a	MT-63 4~65A	14	50	52
TD125HU 60~100A	MC-65a	MT-63 4~65A	14	60	62
TS250HU 150A	MC-75a	MT-95 7~75A	18	60	62
TS250HU 150~200A	MC-85a	MT-95 7~85A	18	75	77
TS250HU 150~200A	MC-100a	MT-95 7~100A	18	75	77
TS250HU 250A	MC-130a	MT-150 34~130A	18	75	77
TS250HU 250A	MC-150a	MT-150 34~130A	18	75	77

Rated UL 508 combination motor controller Type-F

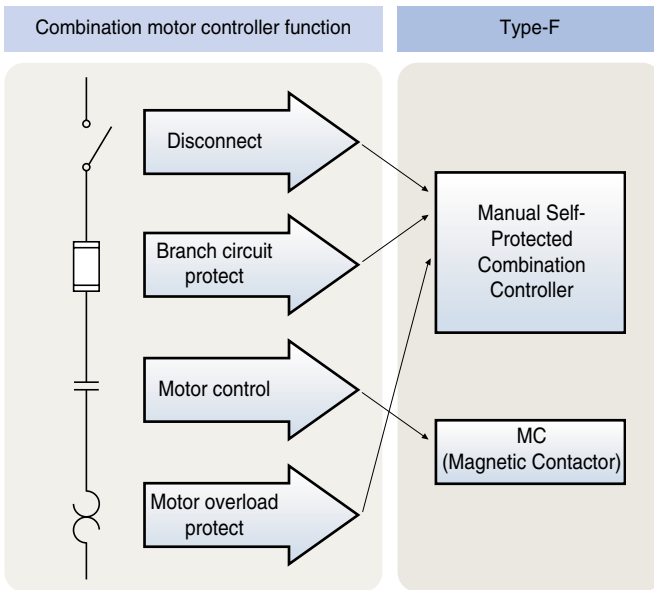

32AF Rotary operation, High interruption

Manual Self-Protected	Adjustment range (A)	Short circuit rating (kA)			MC (Applied contactor)	
		240V	480Y/277V	600Y/347V	Susol	Metasol
MMS-32H-0.16	0.1~0.16	100	65	25	MC-9	MC-6a/MC-9a/MC-9b
MMS-32H-0.25	0.16~0.25	100	65	25	MC-9	MC-6a/MC-9a/MC-9b
MMS-32H-0.4	0.25~0.4	100	65	25	MC-9	MC-6a/MC-9a/MC-9b
MMS-32H-0.63	0.4~0.63	100	65	25	MC-9	MC-6a/MC-9a/MC-9b
MMS-32H-1	0.63~1	100	65	25	MC-9	MC-6a/MC-9a/MC-9b
MMS-32H-1.6	1~1.6	100	65	25	MC-9	MC-6a/MC-9a/MC-9b
MMS-32H-2.5	1.6~2.5	100	65	25	MC-12	MC-12a/MC-12b
MMS-32H-4	2.5~4	100	65	25	MC-12	MC-12a/MC-12b
MMS-32H-6	4~6	100	65	25	MC-18	MC-18a/MC-18b
MMS-32H-8	5~8	100	65	10	MC-18	MC-18a/MC-18b
MMS-32H-10	6~10	100	65	10	MC-18	MC-18a/MC-18b
MMS-32H-13	9~13	100	65	10	MC-25	MC-22b/MC-25a
MMS-32H-17	11~17	100	30	10	MC-25	MC-22b/MC-25a
MMS-32H-22	14~22	100	30	10	MC-25	MC-22b/MC-25a
MMS-32H-26	18~26	100	30	10	MC-32	MC-32a
MMS-32H-32	22~32	100	30	10	MC-32	MC-32a
MMS-32H-40	28~40	100	30	10	-	MC-35a/MC-40a

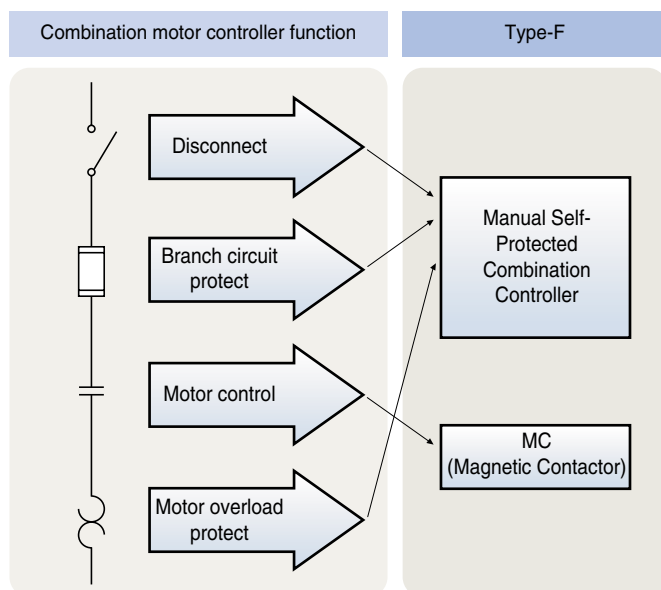

63AF Rotary operation, standard interruption

Manual Self-Protected	Adjustment range (A)	Short circuit rating (kA)			MC (Applied contactor)	
		240V	480Y/277V	600Y/347V	Susol	Metasol
MMS-63S-10	6~10	100	50	10	MC-35	MC-50a
MMS-63S-13	9~13	100	50	10	MC-35	MC-50a
MMS-63S-17	11~17	100	40	10	MC-35	MC-50a
MMS-63S-22	14~22	100	40	10	MC-35	MC-50a
MMS-63S-26	18~26	100	40	10	MC-35	MC-50a
MMS-63S-32	22~32	100	40	10	MC-35	MC-50a
MMS-63S-40	28~40	100	40	10	MC-40	MC-50a
MMS-63S-50	34~50	100	40	10	MC-50	MC-50a
MMS-63S-63	45~63	100	40	10	MC-63	MC-65a
MMS-63S-65	47~65	100	40	10	-	MC-65a

63AF Rotary operation, High interruption

Manual Self-Protected	Adjustment range (A)	Short circuit rating (kA)			MC (Applied contactor)	
		240V	480Y/277V	600Y/347V	Susol	Metasol
MMS-63H-10	6~10	100	65	25	MC-35	MC-50a
MMS-63H-13	9~13	100	65	25	MC-35	MC-50a
MMS-63H-17	11~17	100	50	10	MC-35	MC-50a
MMS-63H-22	14~22	100	50	10	MC-35	MC-50a
MMS-63H-26	18~26	100	50	10	MC-35	MC-50a
MMS-63H-32	22~32	100	50	10	MC-35	MC-50a
MMS-63H-40	28~40	100	50	10	MC-40	MC-50a
MMS-63H-50	34~50	100	50	10	MC-50	MC-50a
MMS-63H-63	45~63	100	50	10	MC-63	MC-65a
MMS-63H-65	47~65	100	40	10	-	MC-65a

Rated UL 508 combination motor controller Type-F

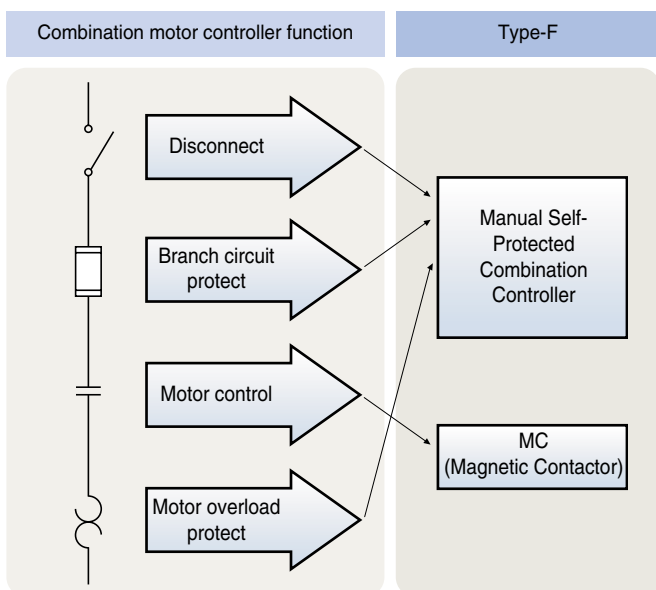

100AF Rotary operation, Standard interruption

Manual Self-Protected	Adjustment range (A)	Short circuit rating (kA)			MC (Applied contactor)	
		240V	480Y/277V	600Y/347V	Susol	Metasol
MMS-100S-17	11~17	100	50	10	MC-65	MC-75a
MMS-100S-22	14~22	100	50	10	MC-65	MC-75a
MMS-100S-26	18~26	100	50	10	MC-65	MC-75a
MMS-100S-32	22~32	100	50	10	MC-65	MC-75a
MMS-100S-40	28~40	100	50	10	MC-65	MC-75a
MMS-100S-50	34~50	100	50	10	MC-65	MC-75a
MMS-100S-63	45~63	100	40	10	MC-65	MC-75a
MMS-100S-75	55~75	100	40	10	MC-75	MC-75a
MMS-100S-90	70~90	100	40	10	MC-85	MC-85a
MMS-100S-100	80~100	100	40	10	MC-95	MC-100a

100AF Rotary operation, High interruption

Manual Self-Protected	Adjustment range (A)	Short circuit rating (kA)			MC (Applied contactor)	
		240V	480Y/277V	600Y/347V	Susol	Metasol
MMS-100H-17	11~17	100	65	25	MC-65	MC-75a
MMS-100H-22	14~22	100	65	20	MC-65	MC-75a
MMS-100H-26	18~26	100	65	20	MC-65	MC-75a
MMS-100H-32	22~32	100	65	20	MC-65	MC-75a
MMS-100H-40	28~40	100	65	20	MC-65	MC-75a
MMS-100H-50	34~50	100	65	20	MC-65	MC-75a
MMS-100H-63	45~63	100	50	10	MC-65	MC-75a
MMS-100H-75	55~75	100	50	10	MC-75	MC-75a
MMS-100H-90	70~90	100	50	10	MC-85	MC-85a
MMS-100H-100	80~100	100	50	10	MC-95	MC-100a

3-pole contactors dimension (18AF/22AF)

MC-6a-18a AC

1NO or 1NC

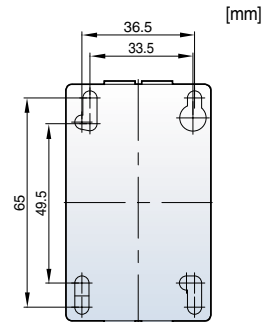
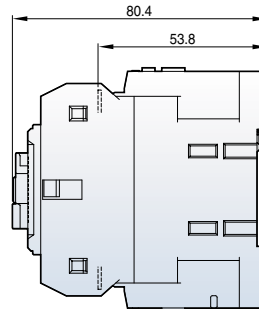
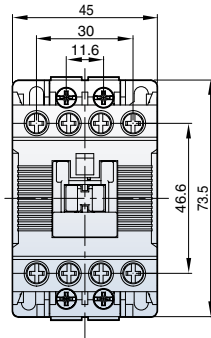

[mm]

0.3kg

MC-6a-18a DC

1NO or 1NC

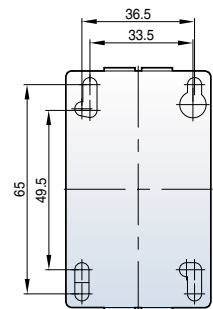
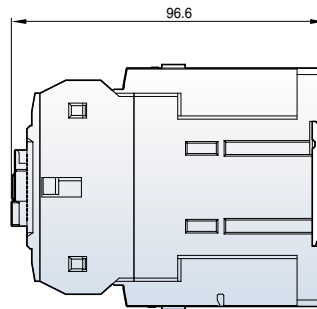
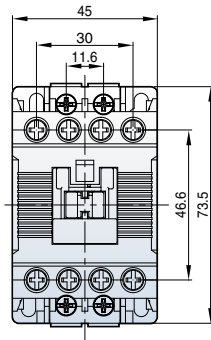

0.5kg

MC-9b-22b AC

1NO1NC

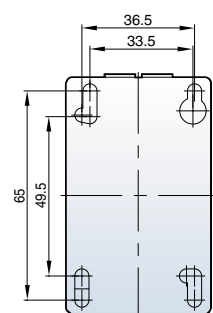
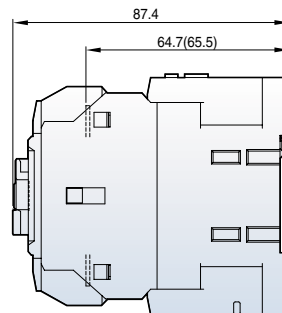
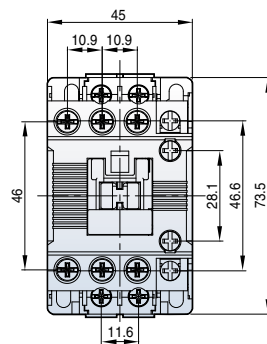

0.3kg

* () MC-18b, 22b

MC-9b-22b DC

1NO1NC

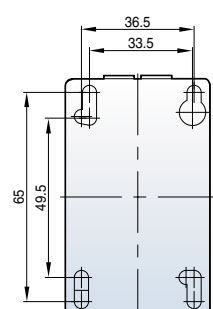
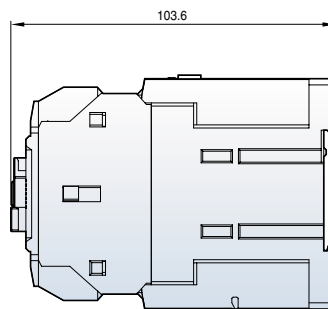
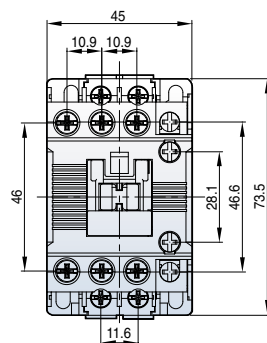

0.5kg

3-pole contactors dimension (40AF)

MC-32a-40a AC

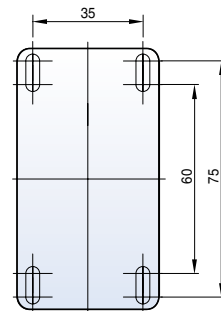
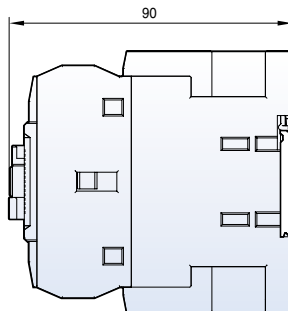
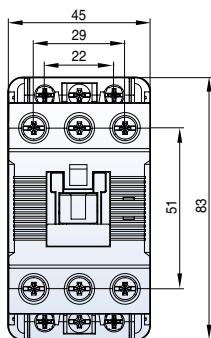

[mm]

0.4kg

MC-32a-40a DC

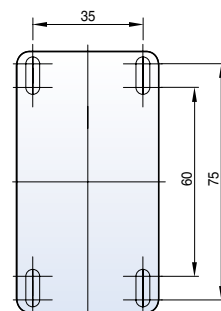
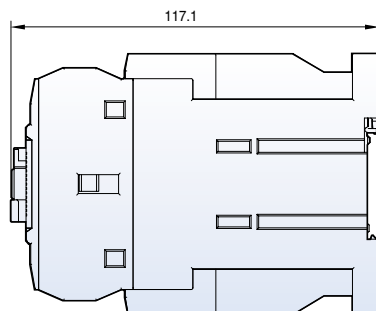
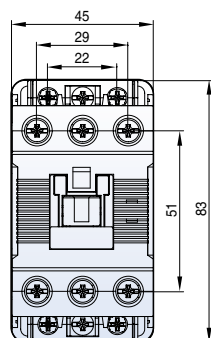

0.6kg

MC-32a-40a AC

2NO2NC

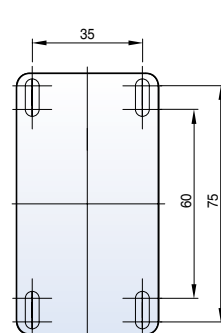
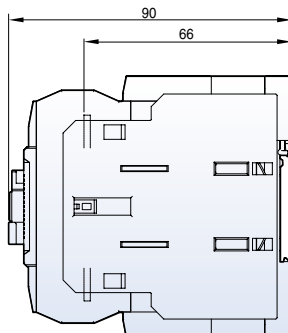
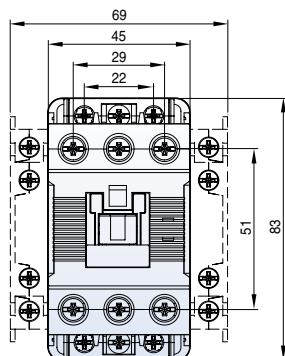

0.5kg

MC-32a-40a DC

2NO2NC

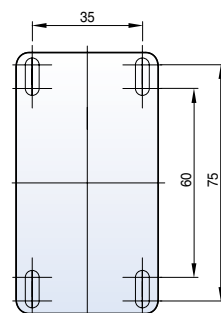
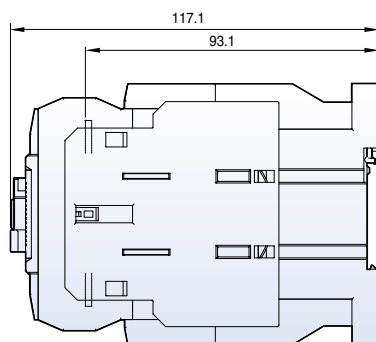
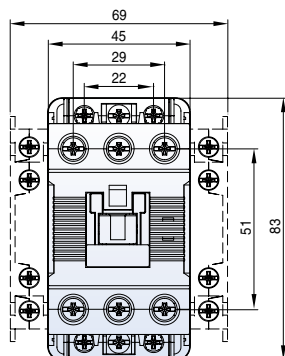

0.8kg

3-pole contactors dimension (65AF)

[mm]

MC-50a-65a AC

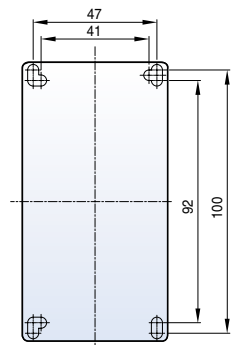
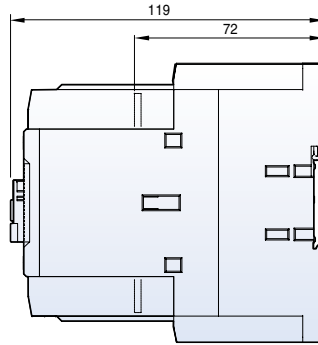
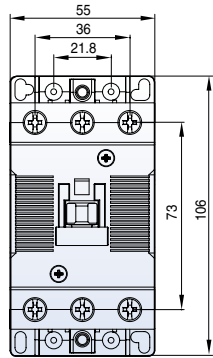

0.9kg

MC-50a-65a DC

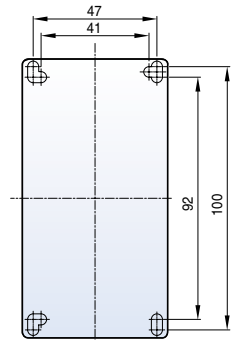
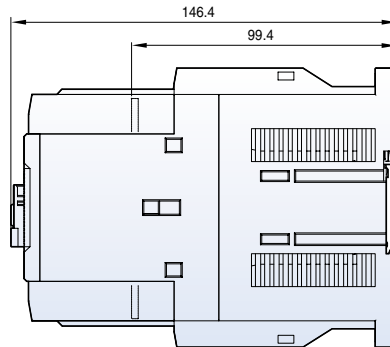
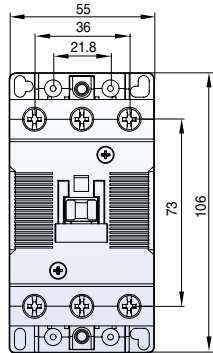

1.2kg

MC-50a-65a AC
2NO2NC

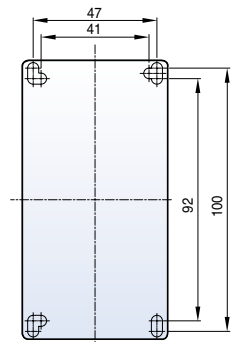
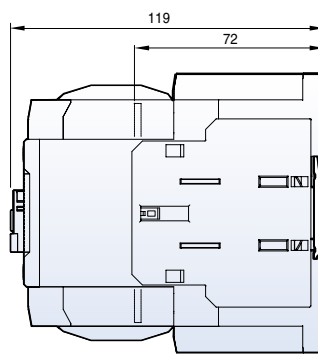
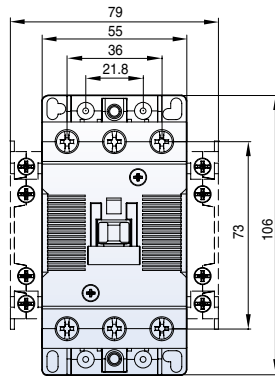

1kg

MC-50a-65a DC
2NO2NC

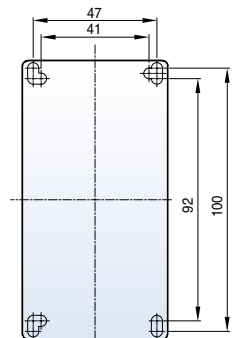
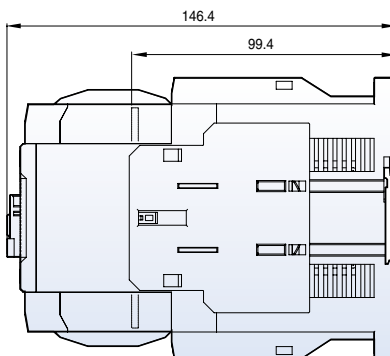
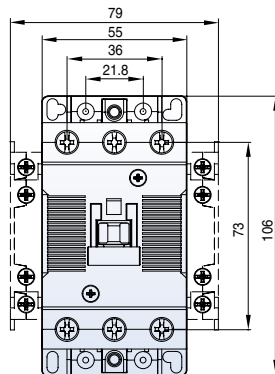

1.3kg

3-pole contactors dimension (100AF)

MC-75a~100a AC

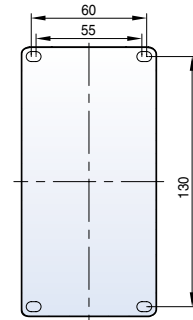
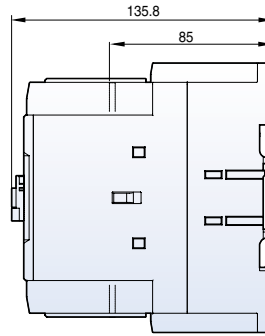
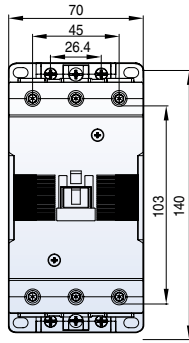

[mm]

1.8kg

MC-75a~100a DC

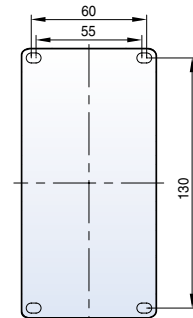
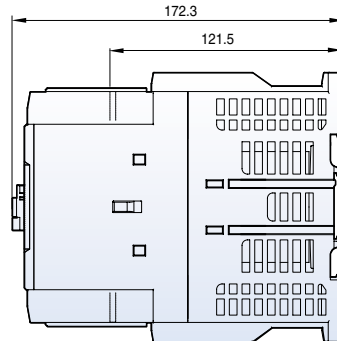
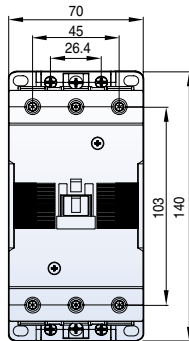

2.7kg

MC-75a~100a AC

2NO2NC

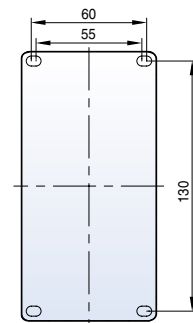
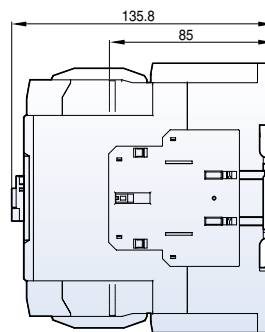
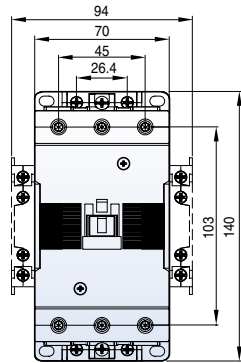

1.9kg

MC-75a~100a DC

2NO2NC

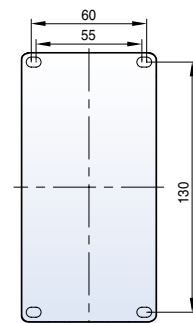
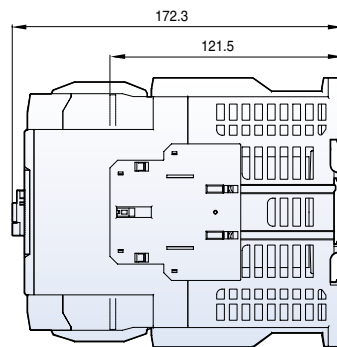
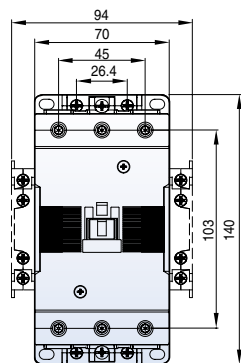

2.8kg

3-pole contactors dimension (150AF~800AF)

- MC-130a
- MC-150a

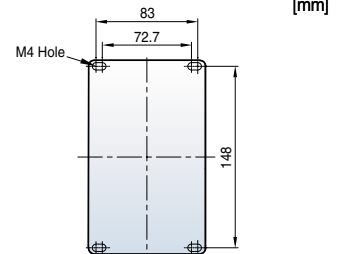
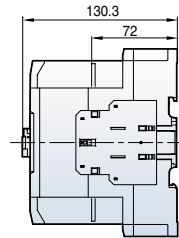
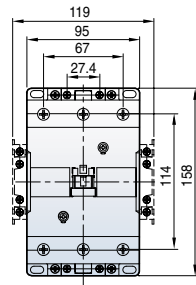

2.4kg

- MC-185a
- MC-225a

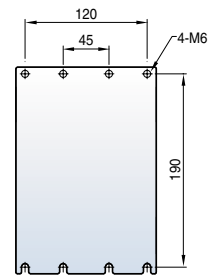
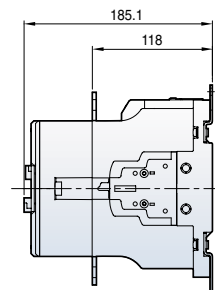
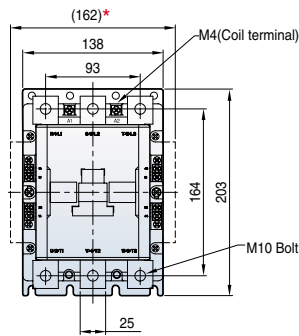

5.4kg

- MC-265a
- MC-330a
- MC-400a

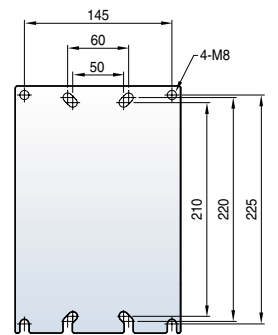
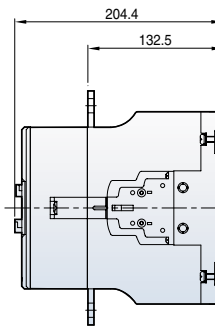
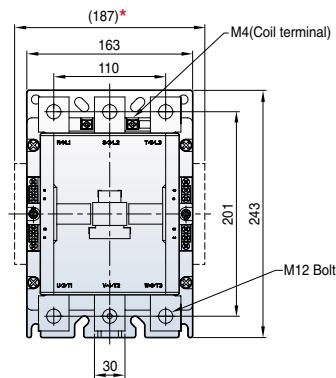

9.2kg

- MC-500a
- MC-630a
- MC-800a

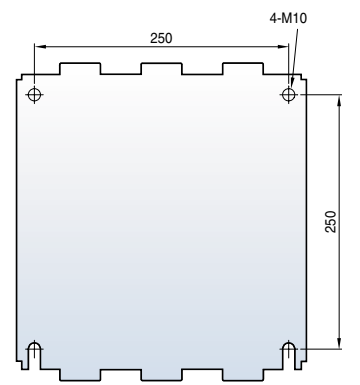
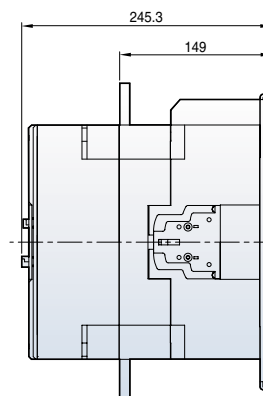
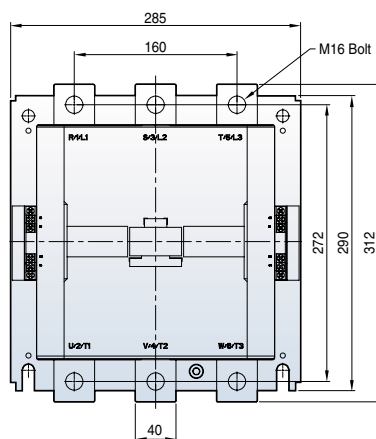

22.4kg

* Optional auxiliary contact unit (side mount type)

Motor starters dimension (18AF~40AF)

MS-6a~18a

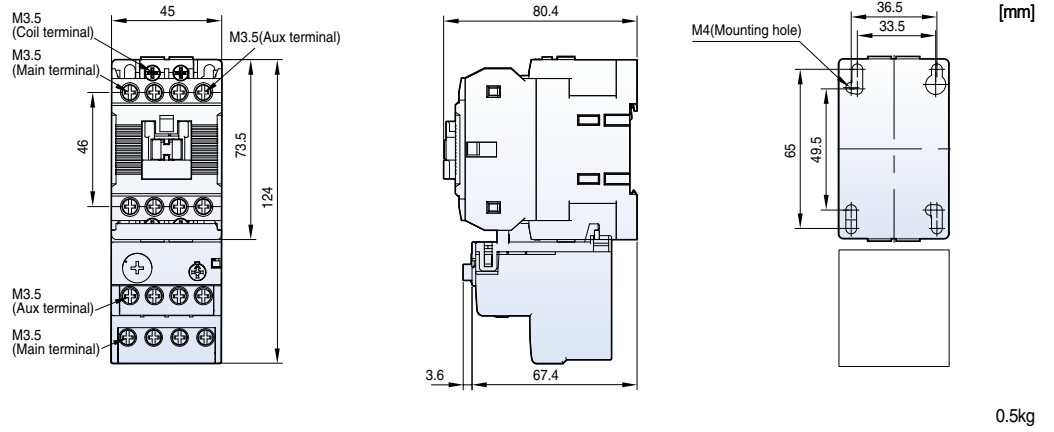

MS-9b~22b

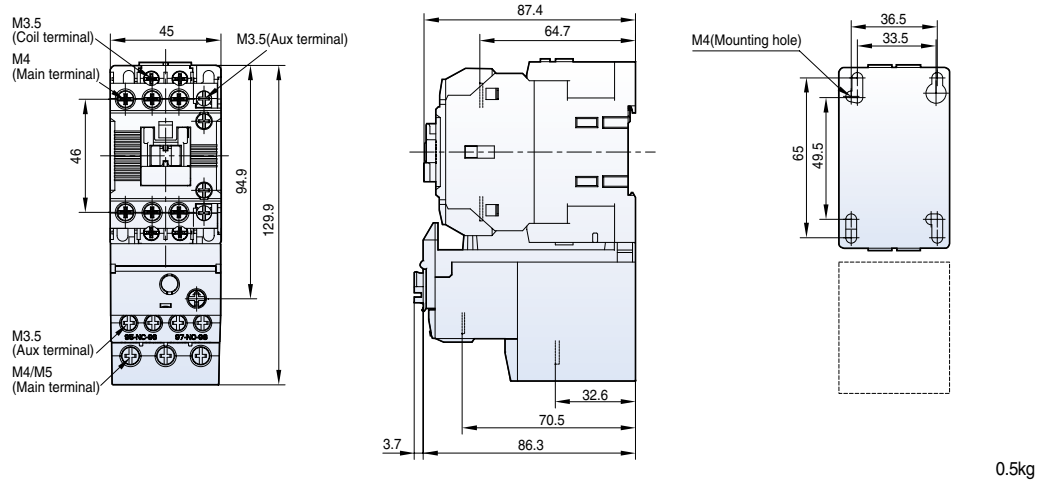

MS-32a~40a

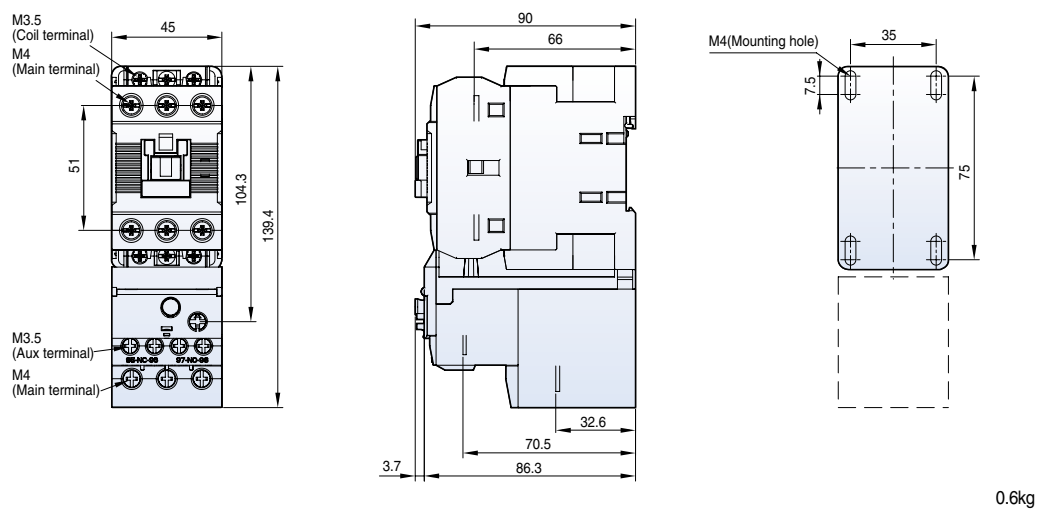

Motor starters dimension (65AF~150AF)

MS-50a~65a

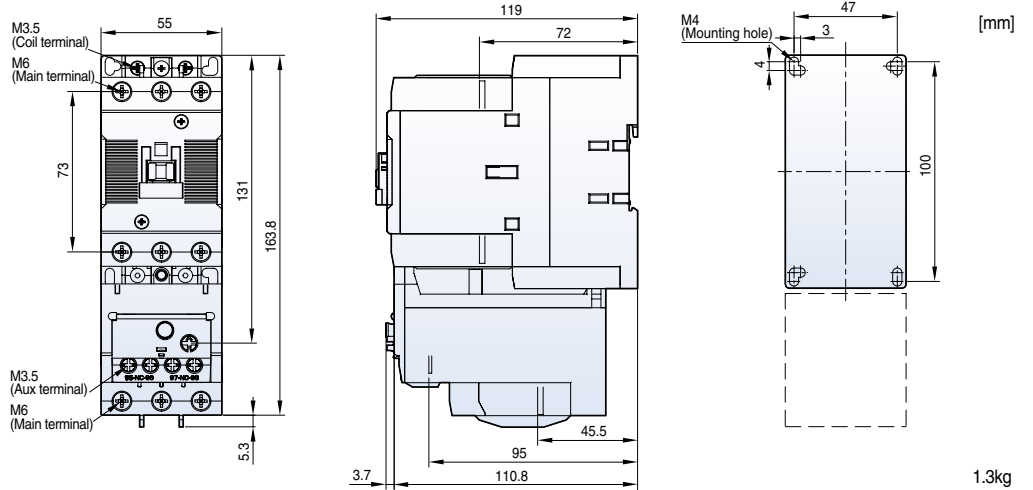

MS-75a~100a

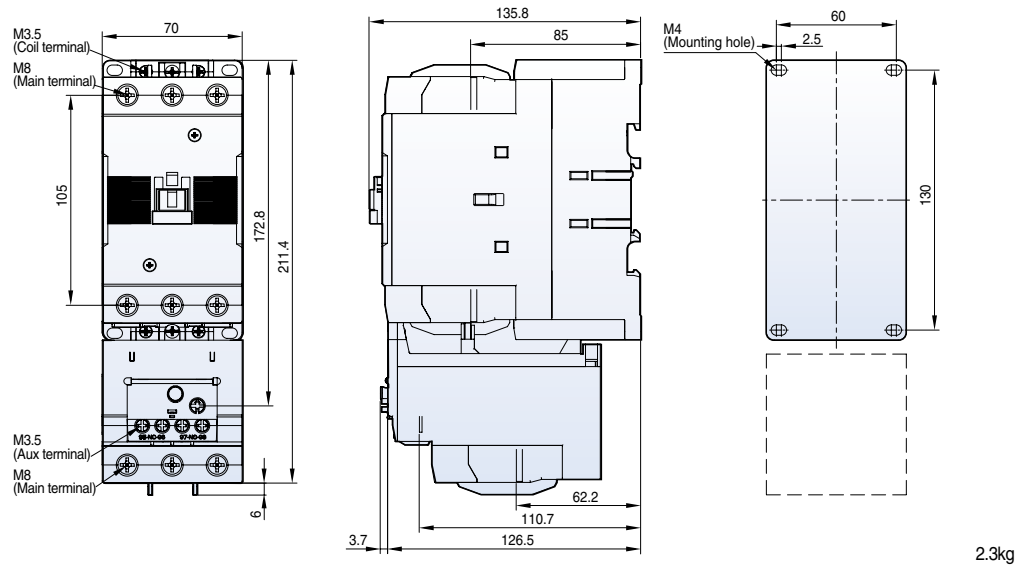

MS-130a

MS-150a

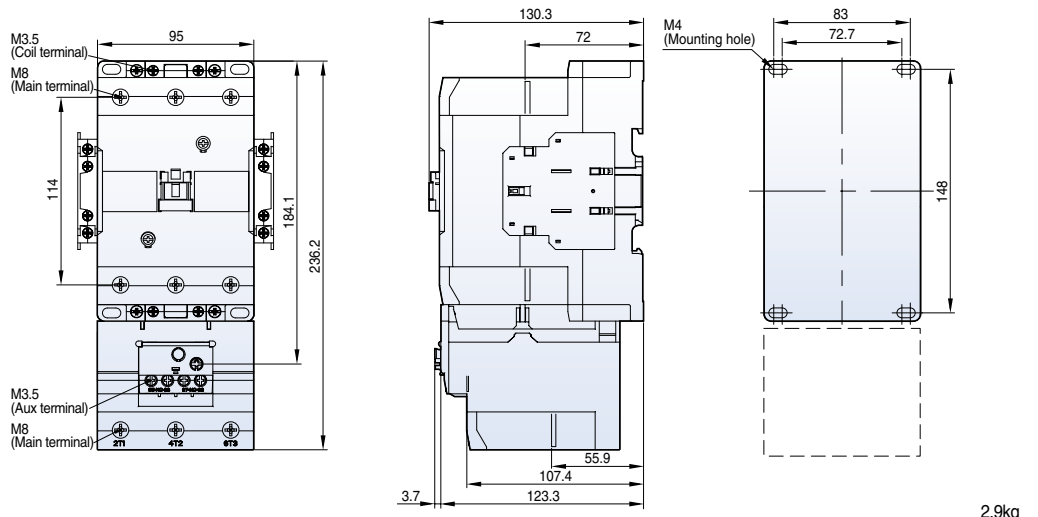

Motor starters dimension (185AF~800AF)

MS-185a

MS-225a

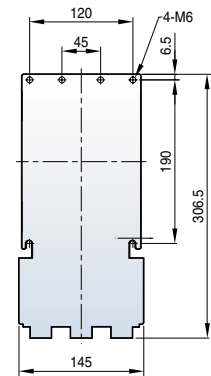
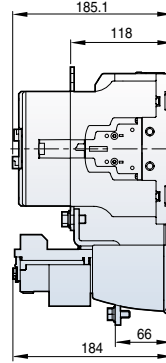
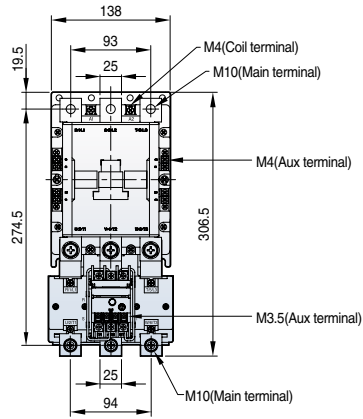

[mm]

7.9kg

MS-265a

MS-330a

MS-400a

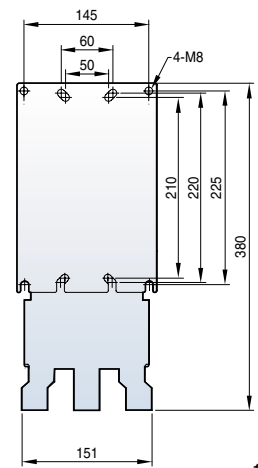
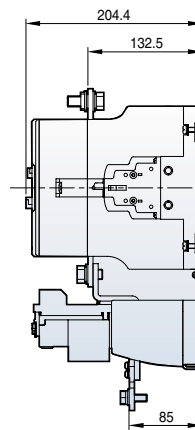
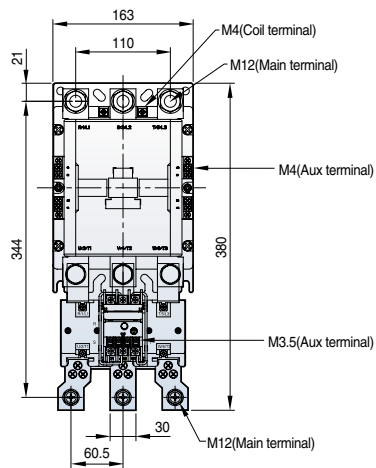

11.8kg

MS-500a

MS-630a

MS-800a

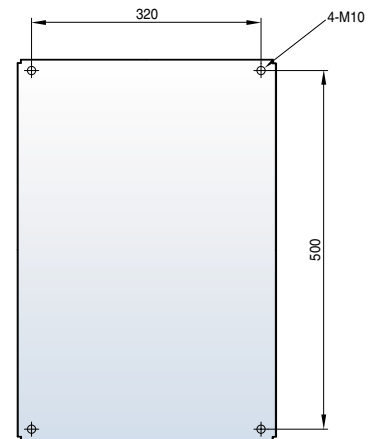
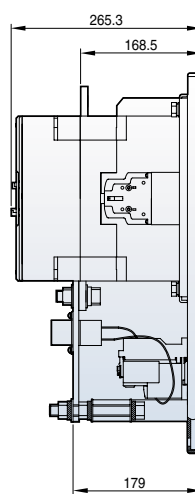
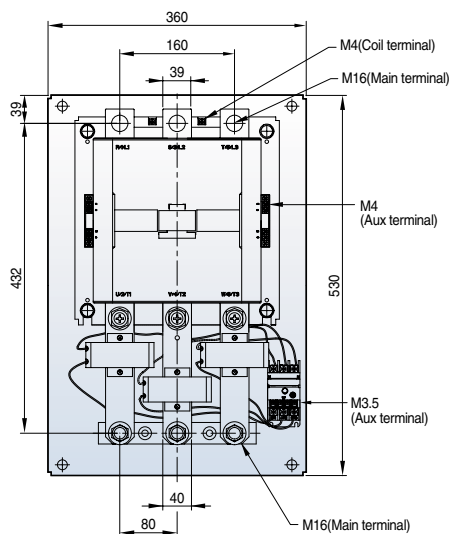

28kg

Reversing contactors and starters dimension (18AF)

[mm]

MC-6aR-18aR AC

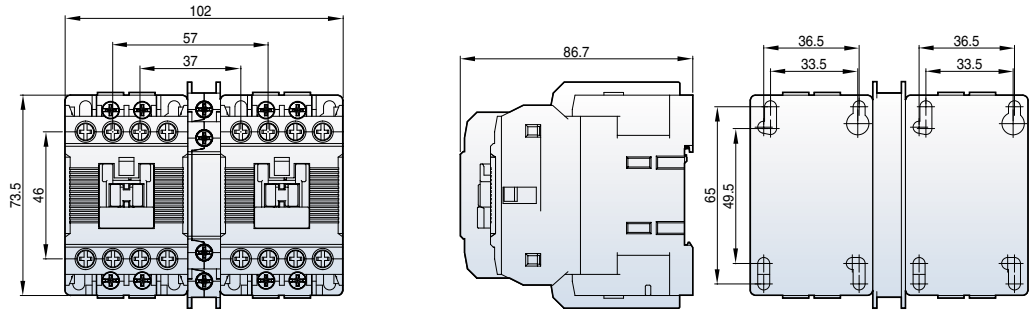

0.7kg

MC-6aR-18aR DC

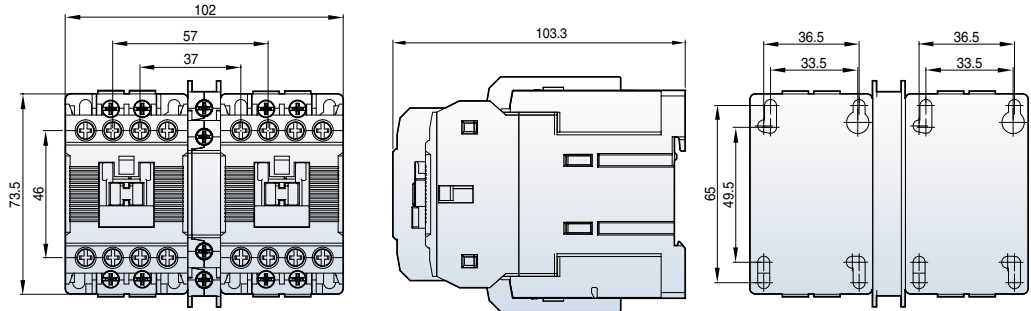

1kg

MS-6aR-18aR AC

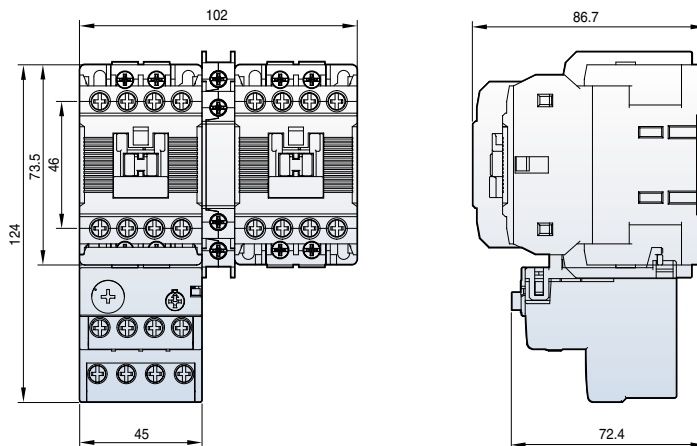

0.9kg

Reversing contactors and starters dimension (22AF)

MC-9bR-22bR AC

[mm]

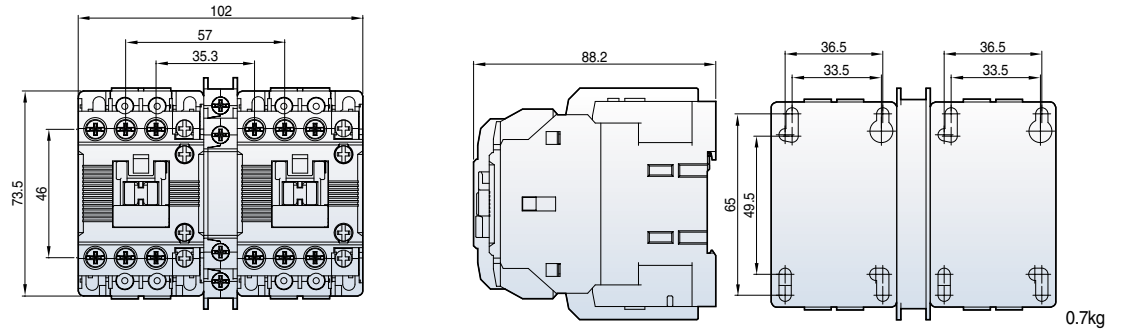

MC-9bR-22bR DC

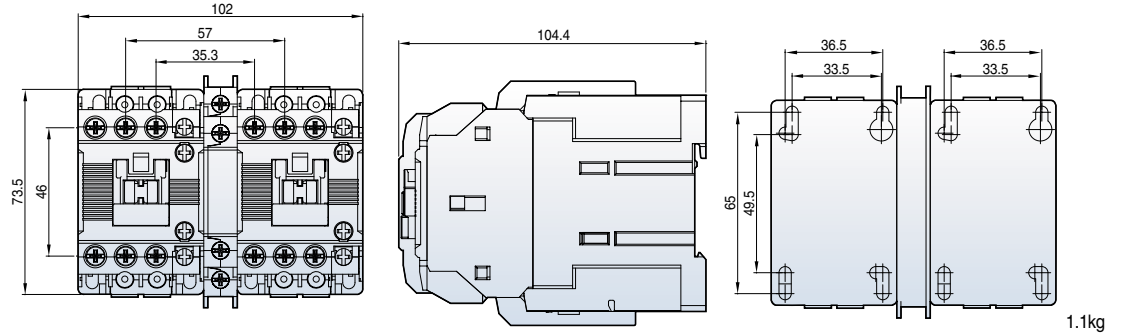

MS-9bR-22bR AC

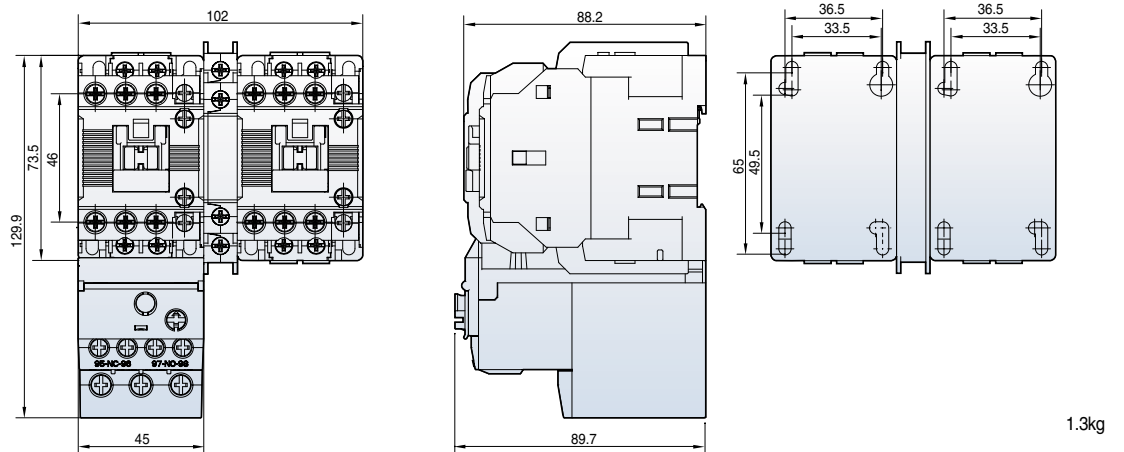

Reversing contactors and starters dimension (40AF)

MC-32aR~40aR AC

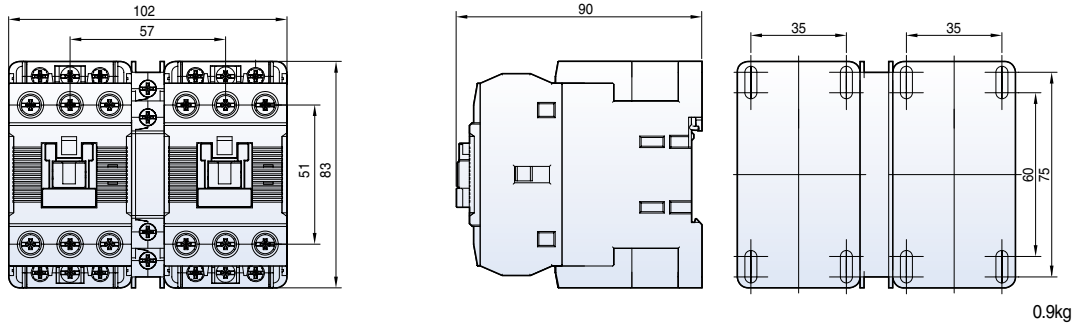

MC-32aR~40aR DC

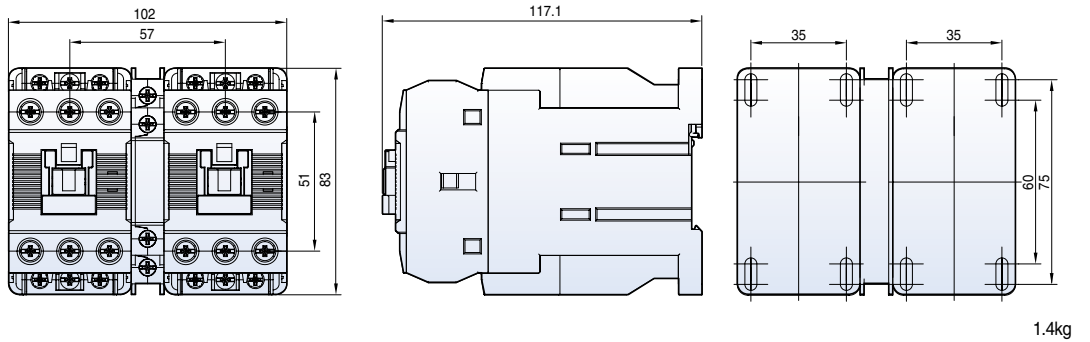

MS-32aR~40aR AC

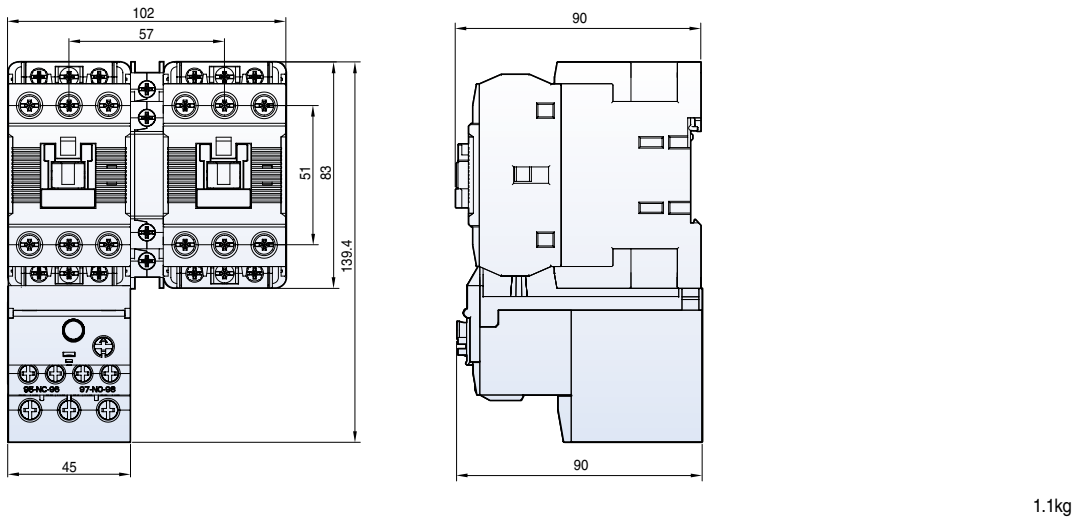

Reversing contactors and starters dimension (65AF)

MC-50aR-65aR AC

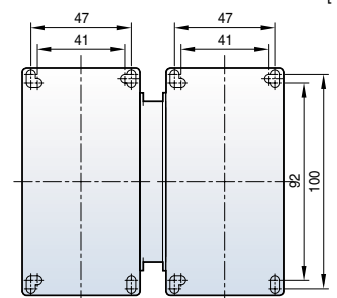
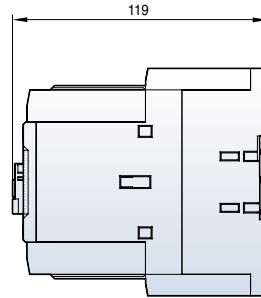
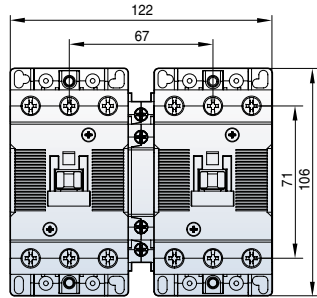

[mm]

1.8kg

MC-50aR-65aR DC

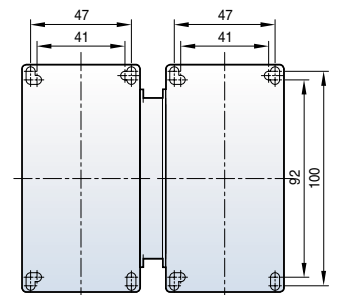
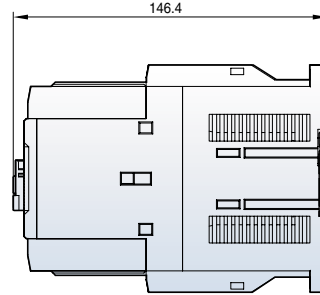
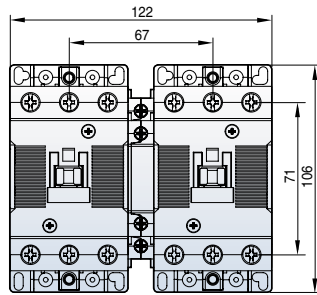

2.4kg

MS-50aR-65aR AC

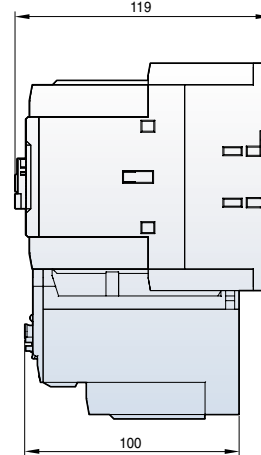
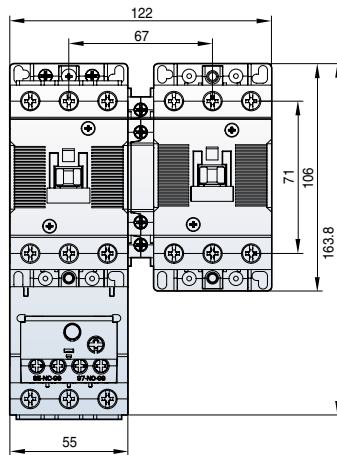

1.9kg

Reversing contactors and starters dimension (100AF)

MC-75aR~100aR AC

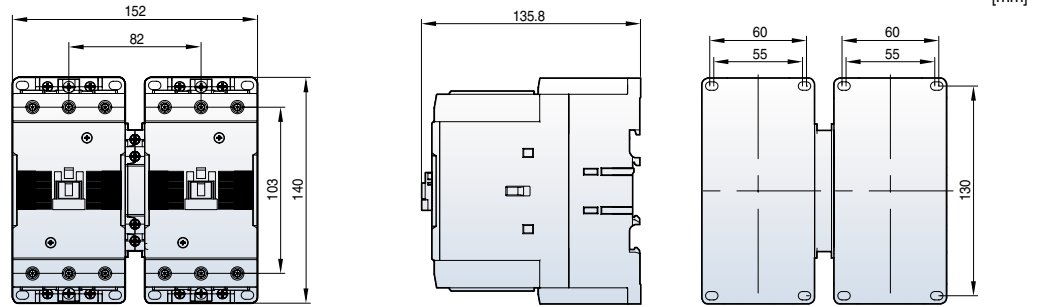

3.3kg

MC-75aR~100aR DC

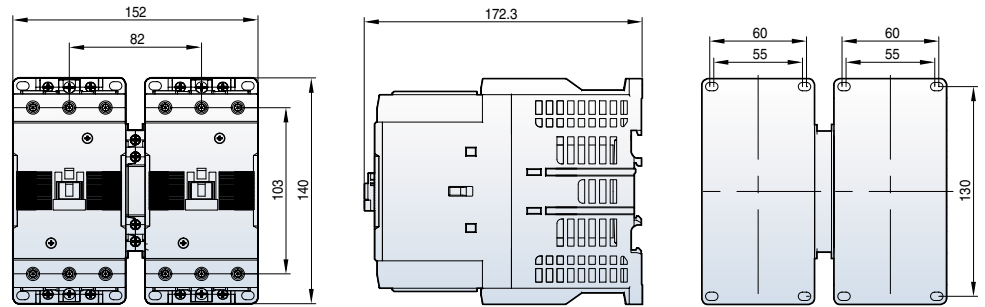

5.2kg

MS-75aR~100aR AC

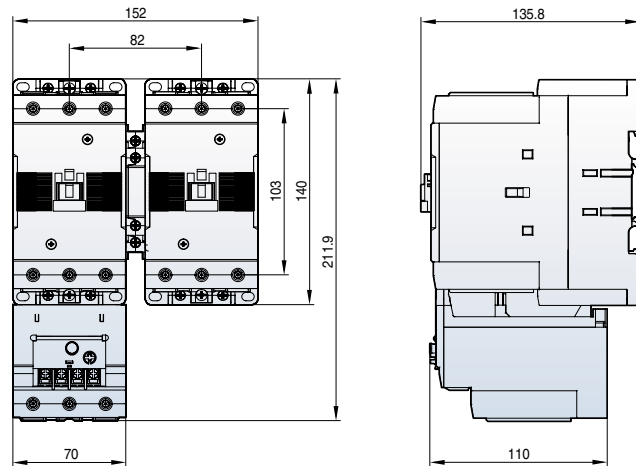

3.8kg

Reversing contactors and starters dimension (150~800AF)

MC-130aR
MC-150aR

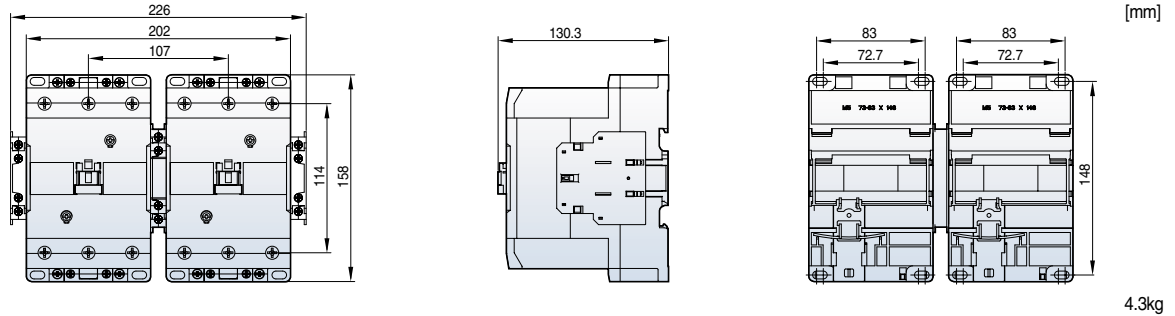

MC-185aR
MC-225aR

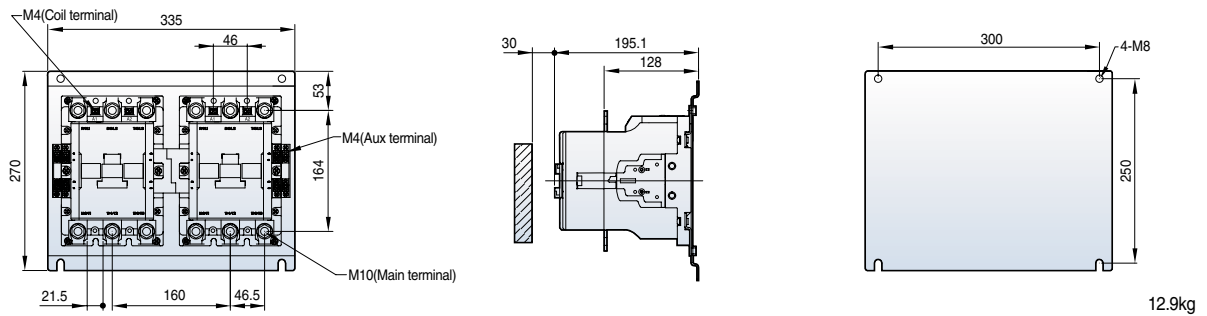

MC-265aR
MC-330aR
MC-400aR

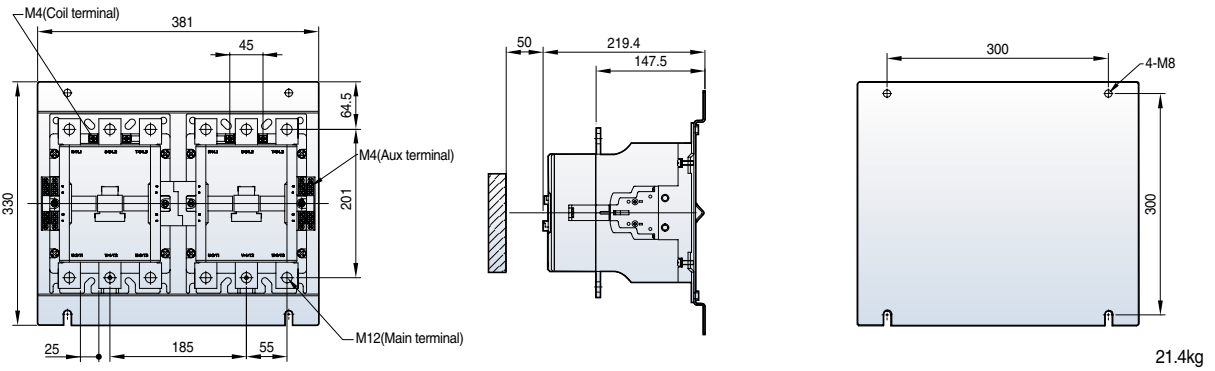

MC-500aR
MC-630aR
MC-800aR

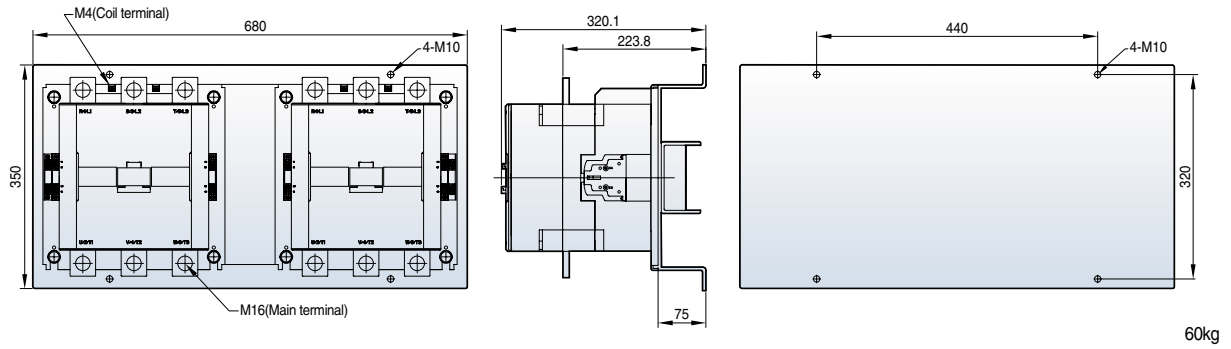

Reversing contactors and starters dimension (150~400AF)

[mm]

- MS-130aR AC
- MS-150aR AC

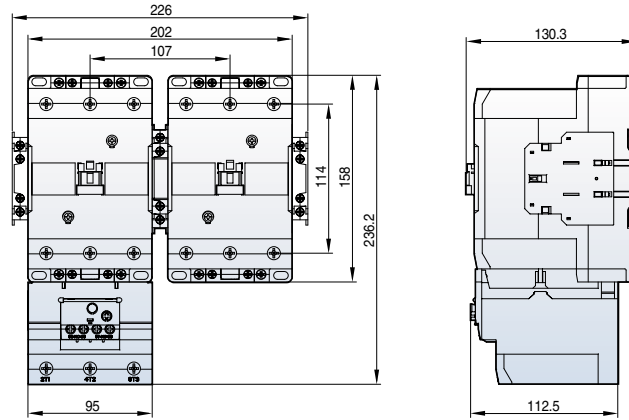

5kg

- MS-185aR AC
- MS-225aR AC

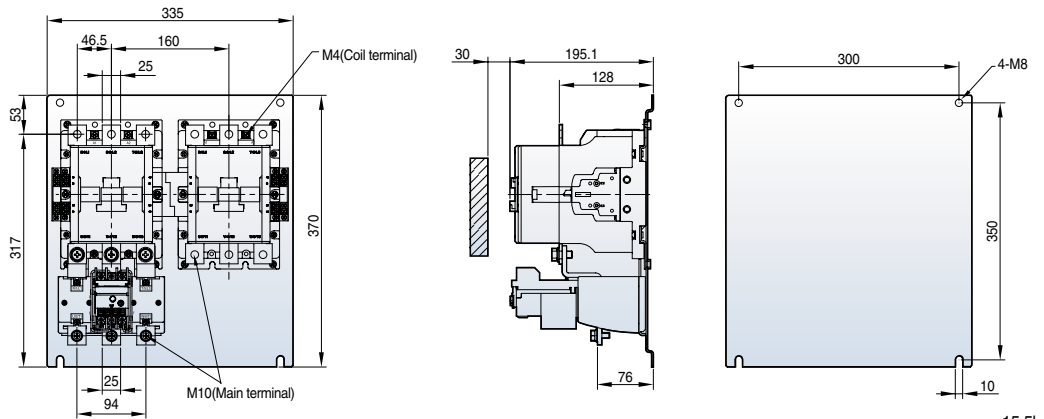

15.5kg

- MS-265aR DC
- MS-330aR DC
- MS-400aR DC

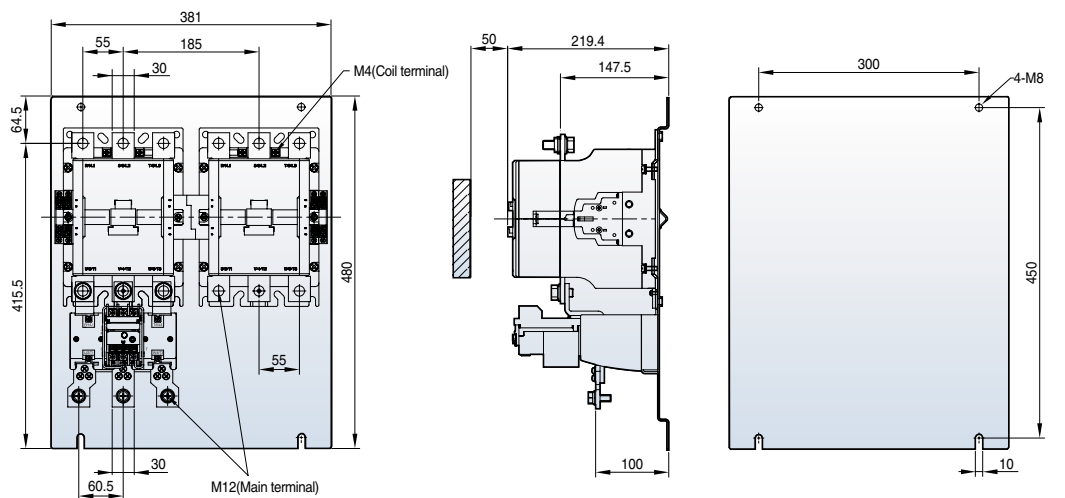

23kg

Contactor relays dimension

MR-4 (D)

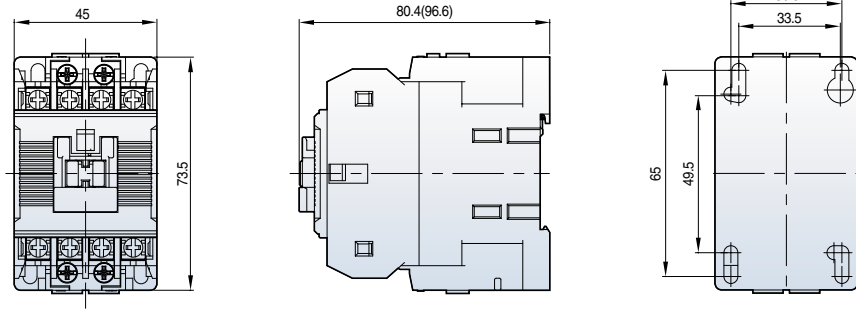

[mm]

284g

MR-6 (D)

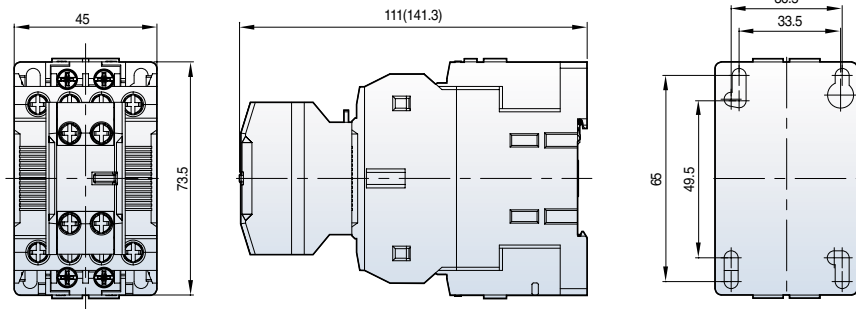

315g

MR-8 (D)

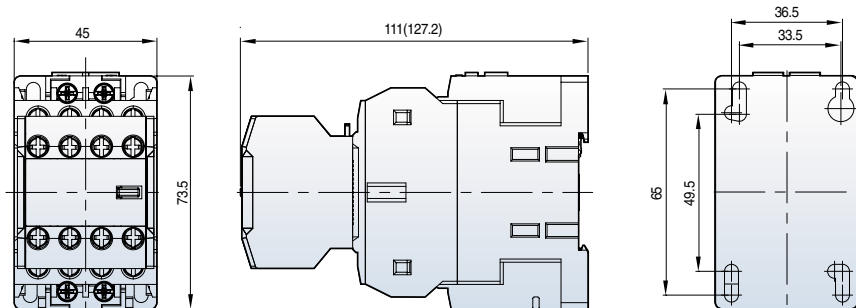

339g

Composition

MR-4	
MR-6	
MR-8	

Note) 1. UA-2: Auxiliary contact units 2. UA-4: Auxiliary contact units

- Please refer to the contact diagram represented on catalog when contactor relays MR-4, 4D and auxiliary contact units UA-2,4 are purchased separately.
- Be sure to order the auxiliary contact units separately except for the above contact units. • () : Dimension for DC control contactor relays

Latching contactors dimension (18AF/22AF)

MC-6a-18a AC

1NO or 1NC + ML-65

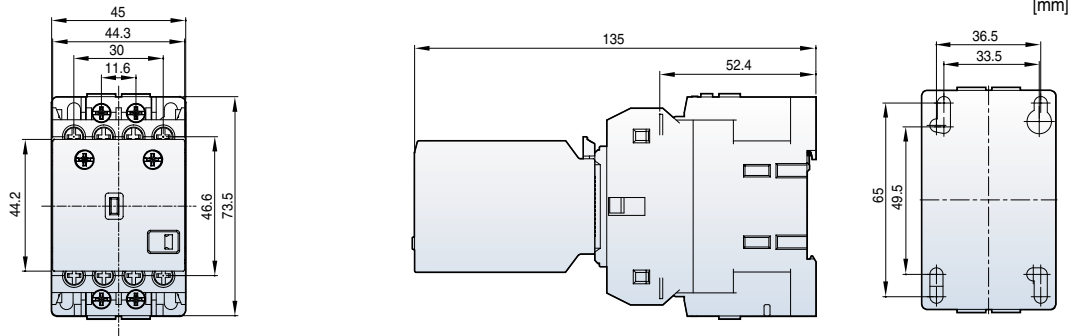

MC-6a-18a DC

1NO or 1NC + ML-65

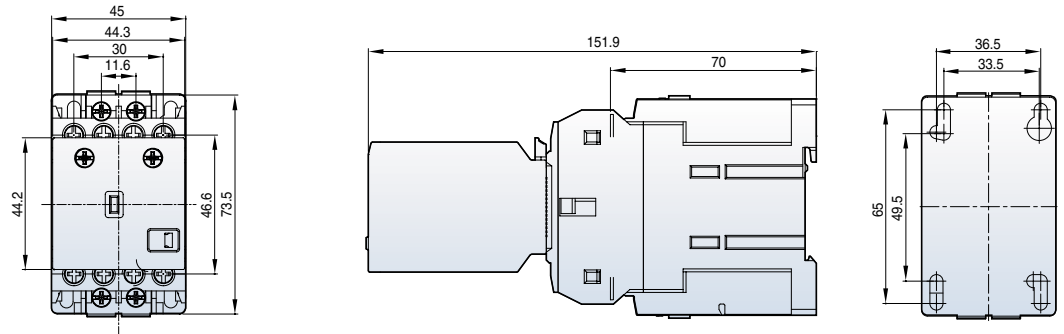

MC-9b-22b AC

1NO1NC + ML-65

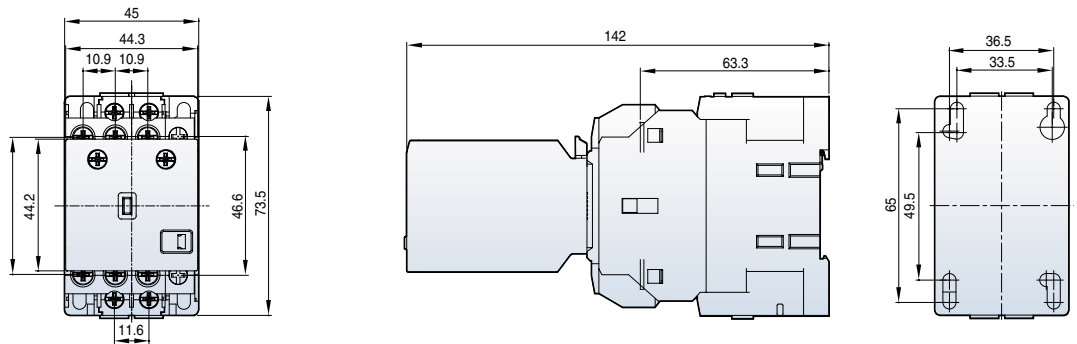

MC-9b-22b DC

1NO1NC + ML-65

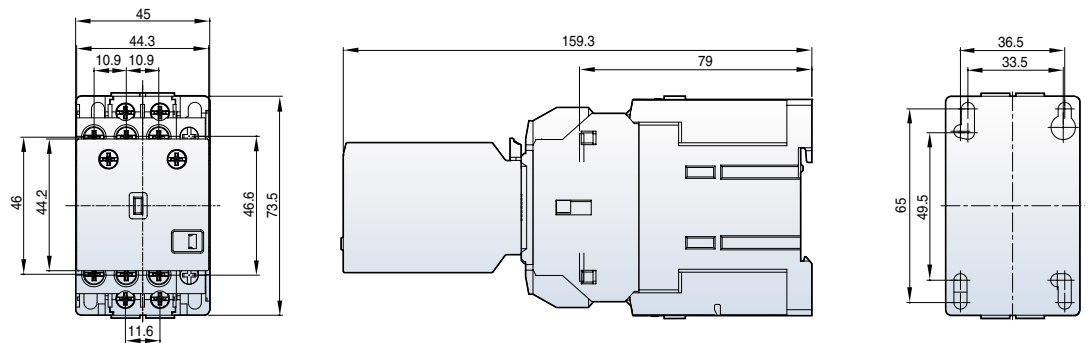

Latching contactors dimension (40AF)

MC-32a-40a AC
+ML-65

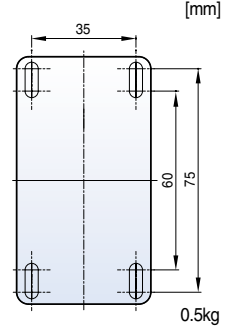
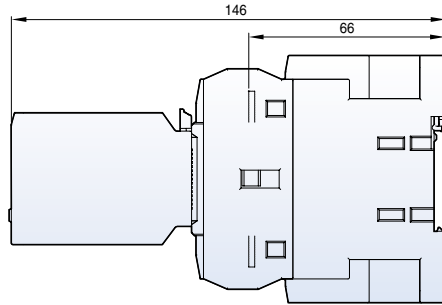
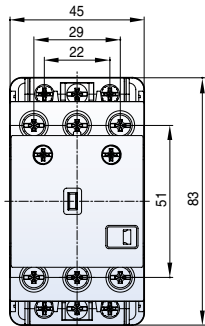

MC-32a-40a DC
+ ML-65

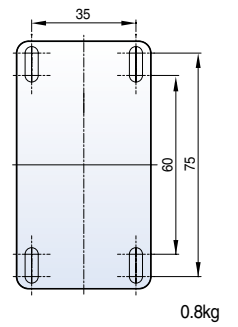
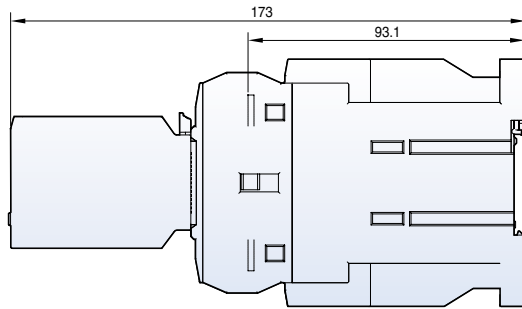
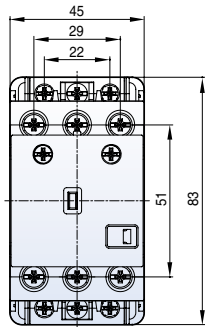

MC-32a-40a AC
2NO2NC + ML-65

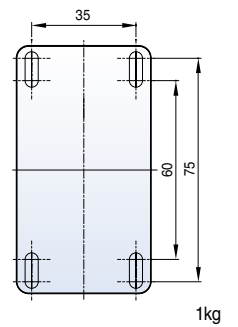
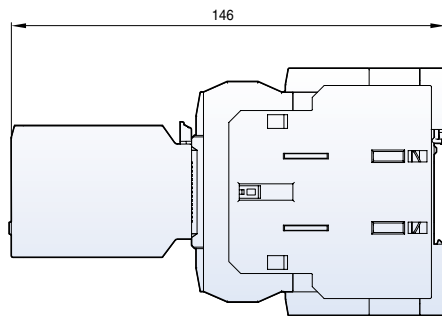
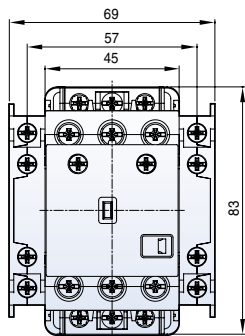

MC-32a-40a DC
2NO2NC + ML-65

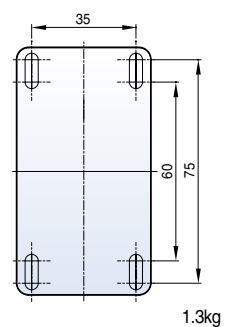
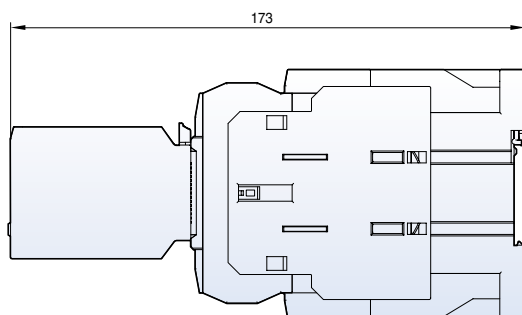
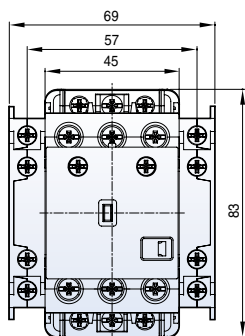

Latching contactors dimension (65AF)

MC-50a-65a AC

+ ML-65

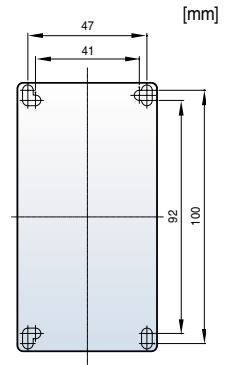
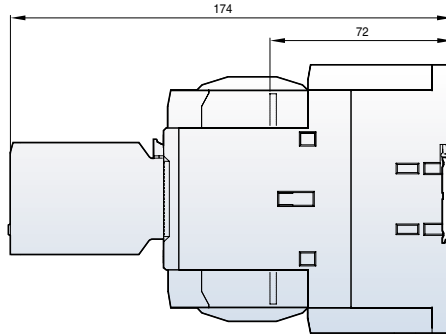
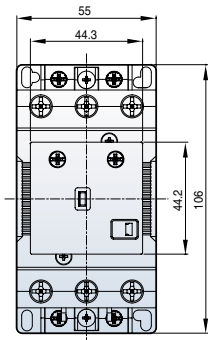

1.9kg

MC-50a-65a DC

+ ML-65

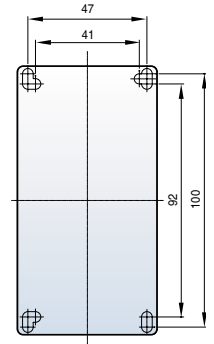
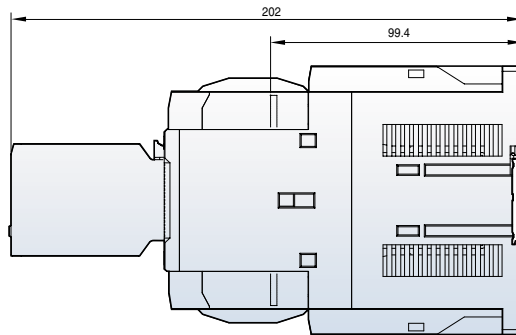
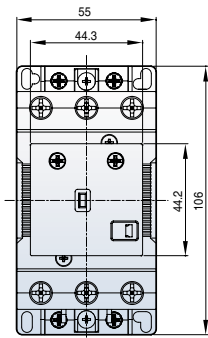

2.8kg

MC-50a-65a AC

2NO2NC + ML-65

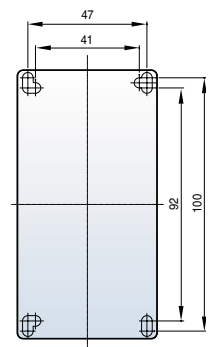
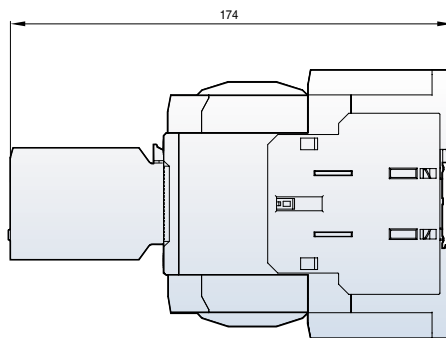
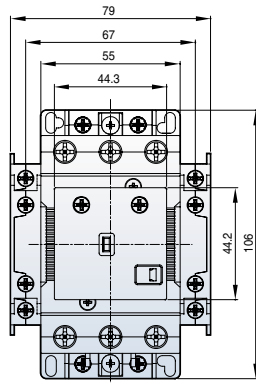

2.4kg

MC-50a-65a DC

2NO2NC + ML-65

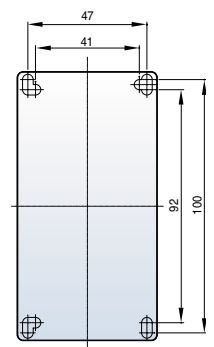
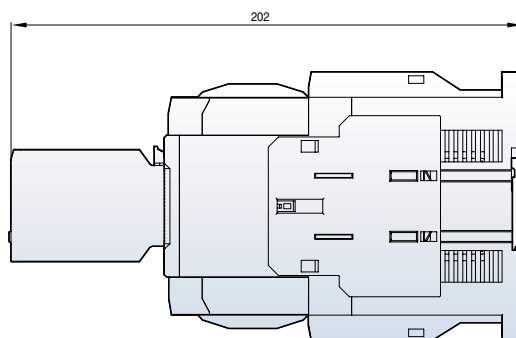
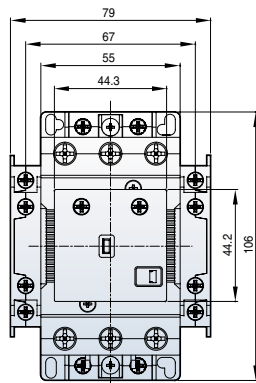

2.4kg

Latching contactors dimension (100AF)

MC-75a-100a AC
+ ML-150

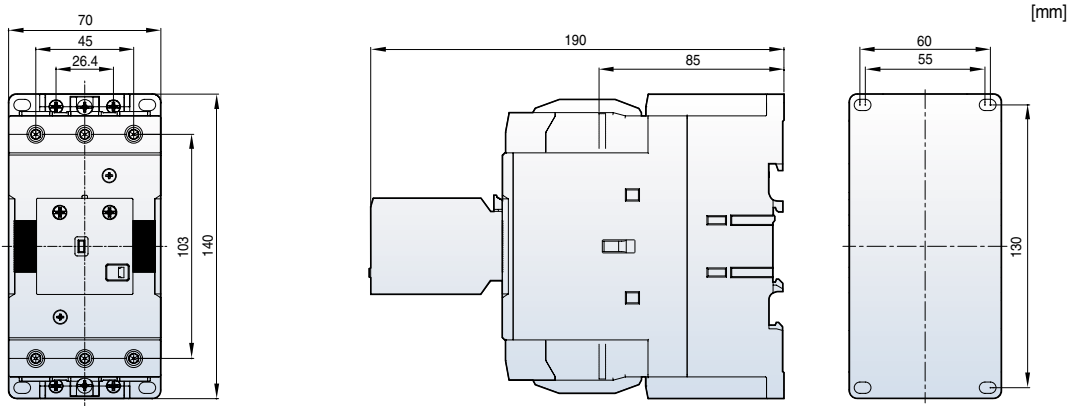

MC-75a-100a DC
+ ML-150

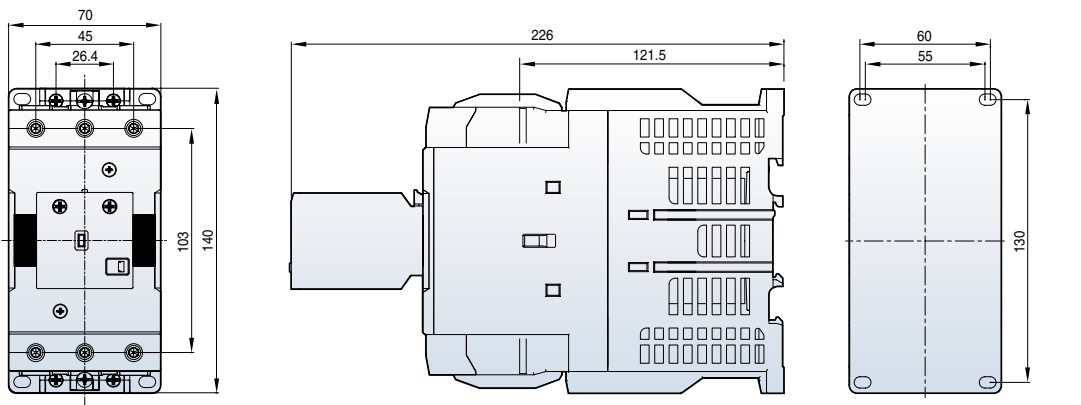

MC-75a-100a AC
2NO2NC + ML-150

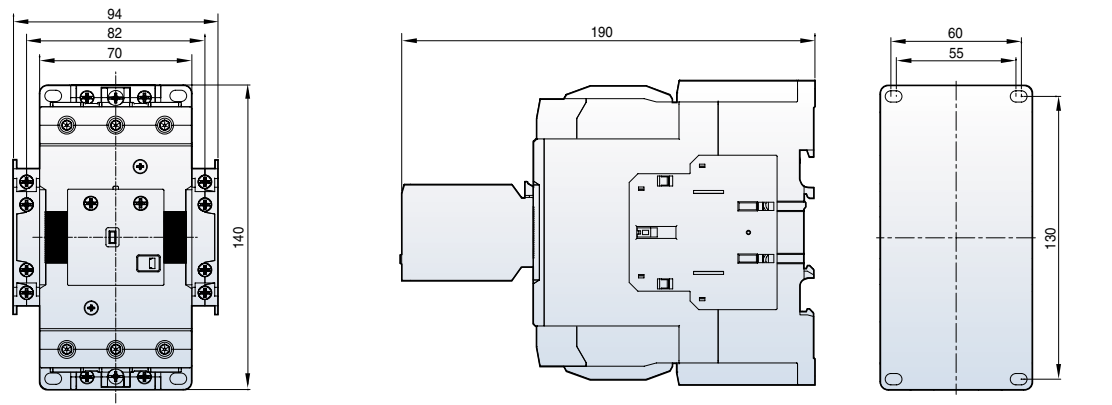

MC-75a-100a DC
2NO2NC + ML-150

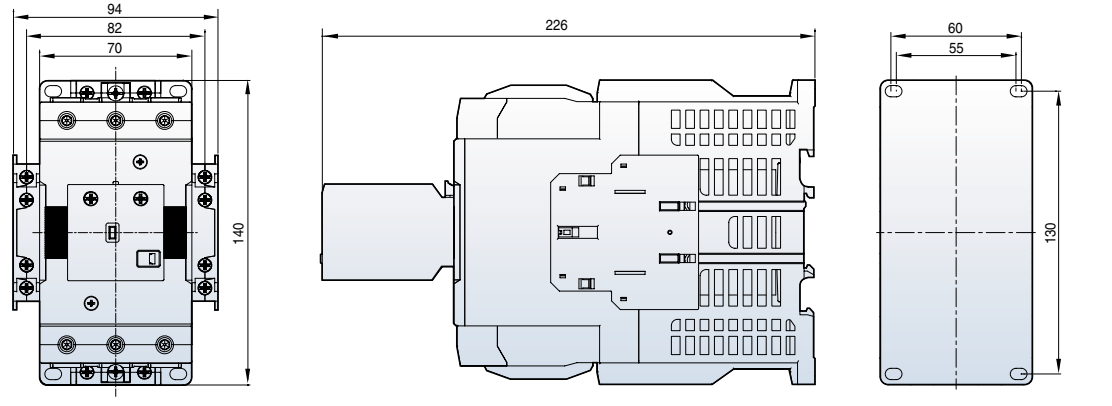

Latching contactors dimension (150AF~400AF)

[mm]

MC-130a~150a
2NO2NC + ML-150

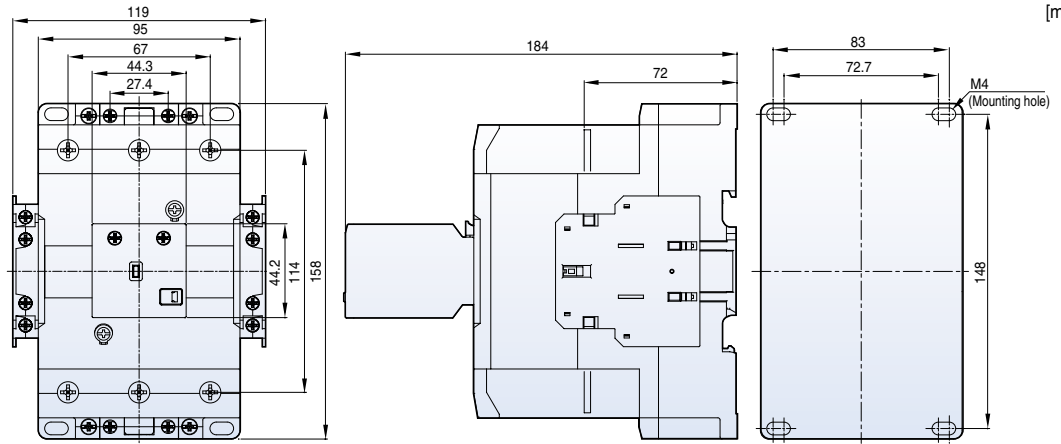

MC-185a
MC-225a

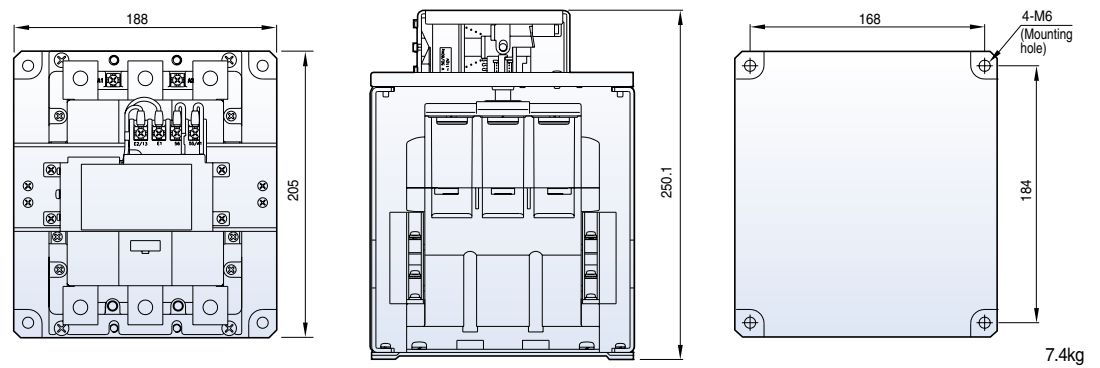

MC-265a
MC-330a
MC-400a

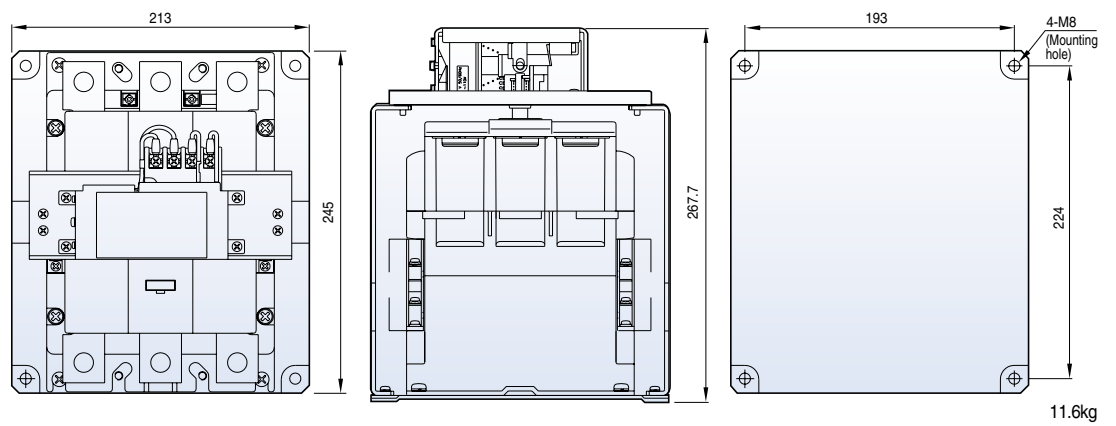

Composition

MC-185a/L~400a/L

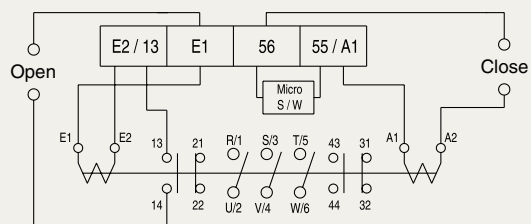

4-pole contactors dimension (MC-6a/4~22a/4)

MC-6a/4~18a/4 AC

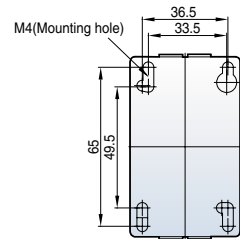
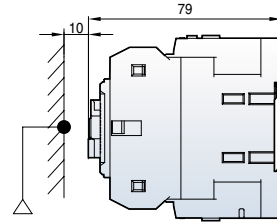
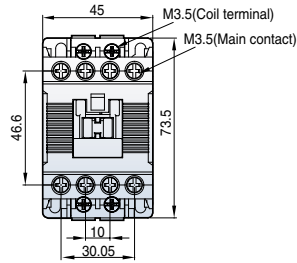

[mm]

0.3kg

MC-6a/4~18a/4 DC

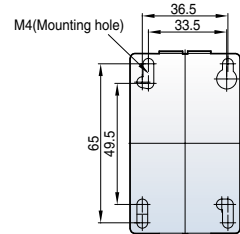
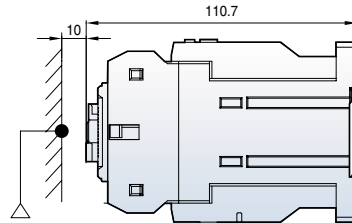
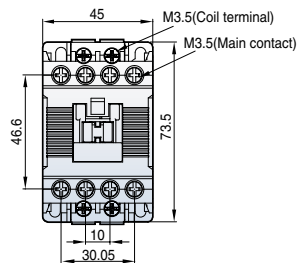

0.45kg

MC-22a/4 AC

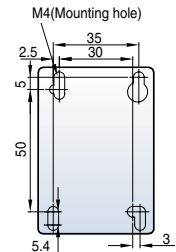
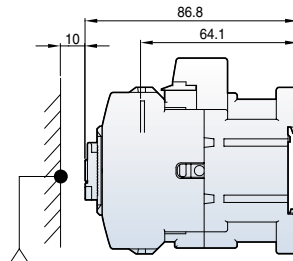
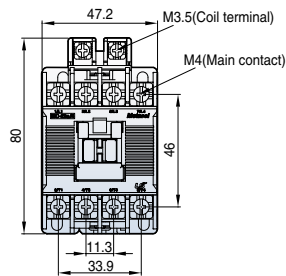

0.4kg

MC-22a/4 DC

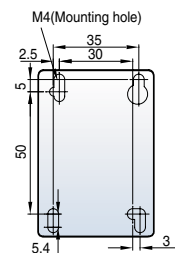
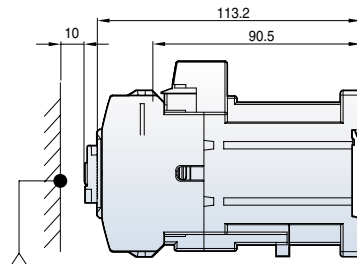
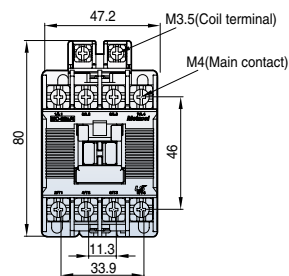

0.5kg

4-pole contactors dimension (MC-32a/4~85a/4)

MC-32a/4~40a/4 AC

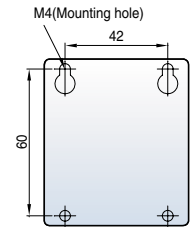
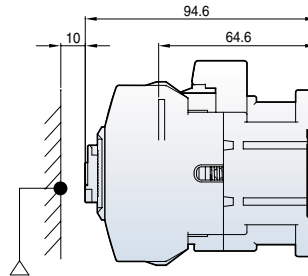
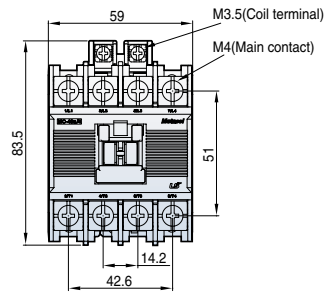

[mm]

0.59kg

MC-32a/4~40a/4 DC

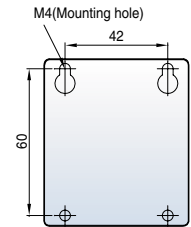
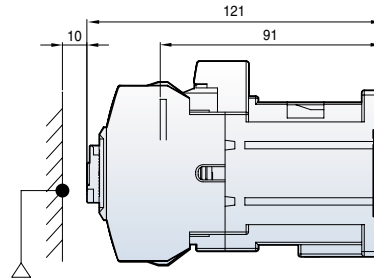
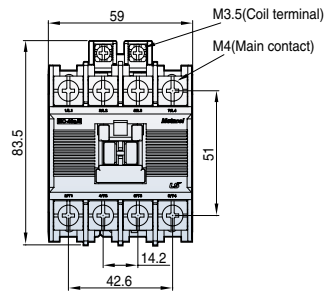

0.7kg

MC-50a/4~85a/4 AC

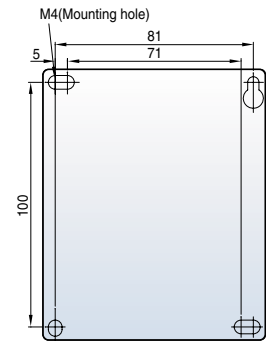
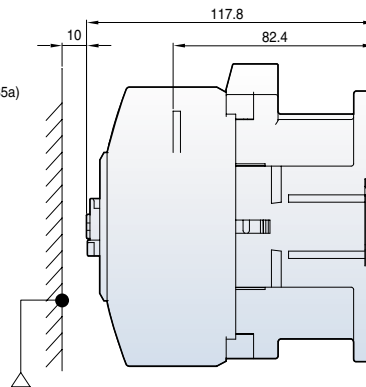
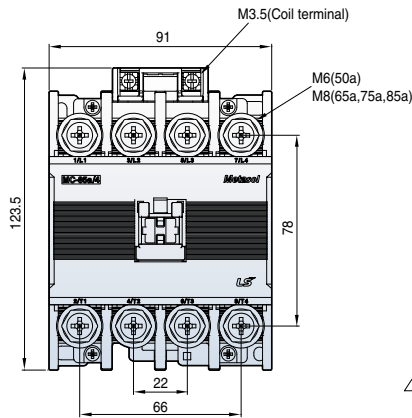

1.2kg

MC-50a/4~85a/4 DC

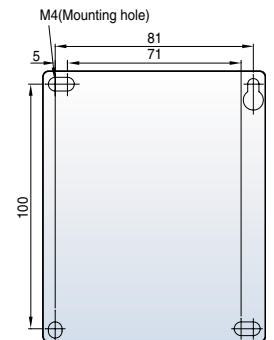
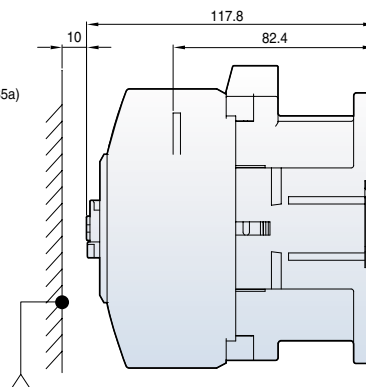
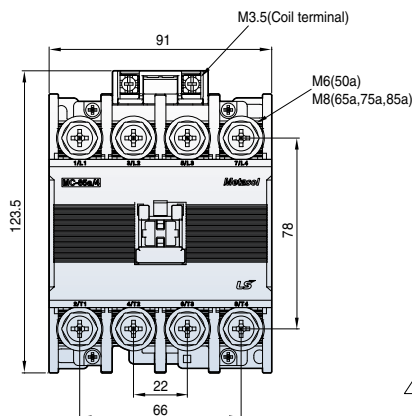

4-pole contactors dimension (MC-100a/4~800a/4)

[mm]

- MC-100a/4
- MC-130a/4
- MC-150a/4
- MC-185a/4
- MC-225a/4

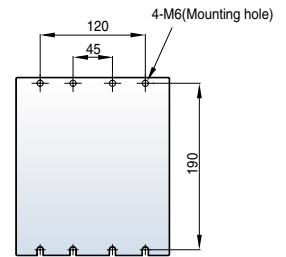
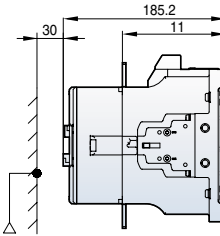
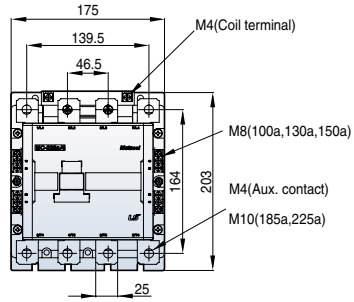

5.6kg

- MC-265a/4
- MC-330a/4
- MC-400a/4

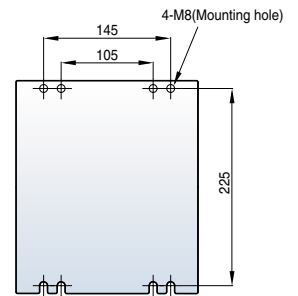
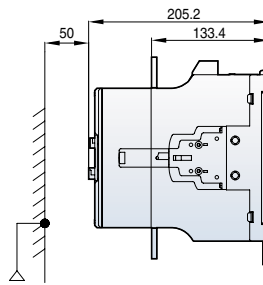
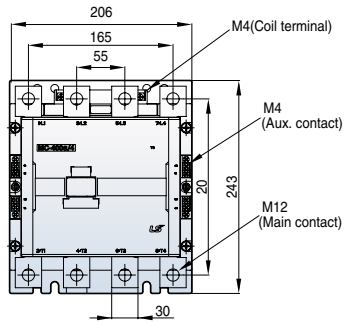

9.9kg

- MC-500a/4
- MC-630a/4
- MC-800a/4

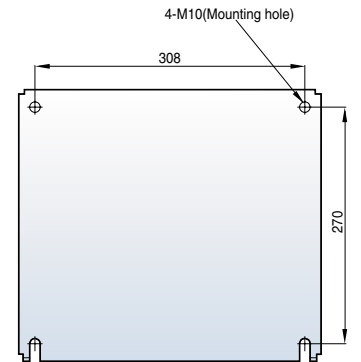
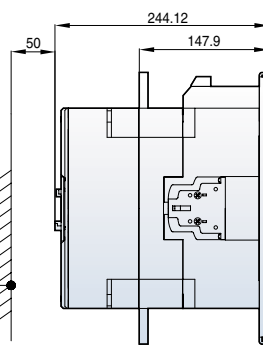
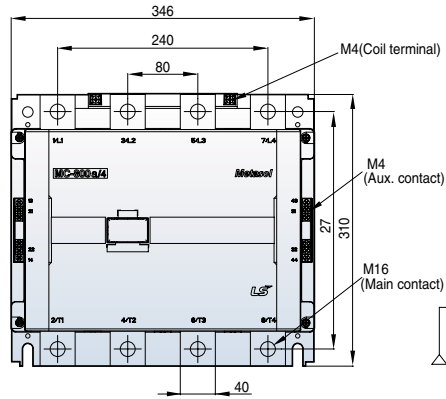

26.3kg

Enclosed motor starters, Mold enclosure dimension

MW-9bM~22bM

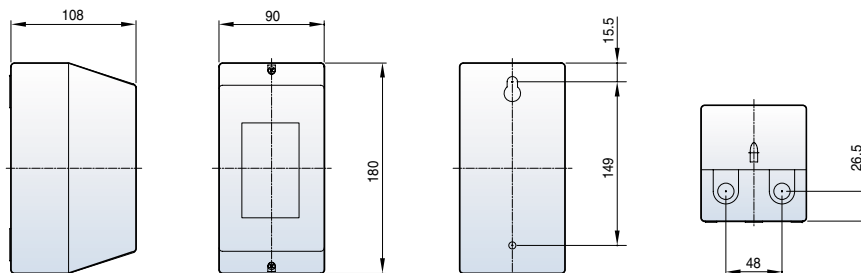

[mm]

0.8kg

MW-9bMB~22bMB

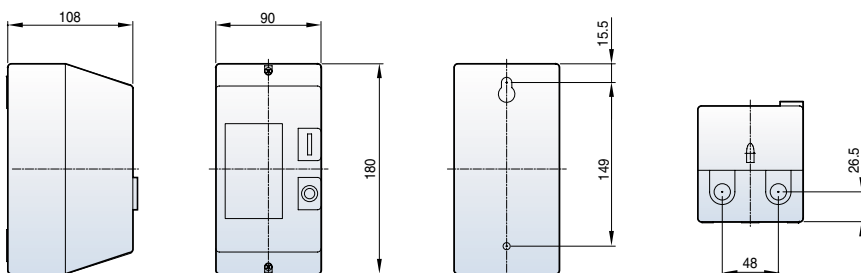

0.8kg

Circuit diagram

MW-9bM~22bM

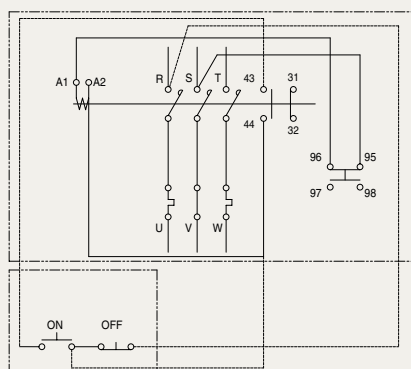

MW-9bMB~22bMB

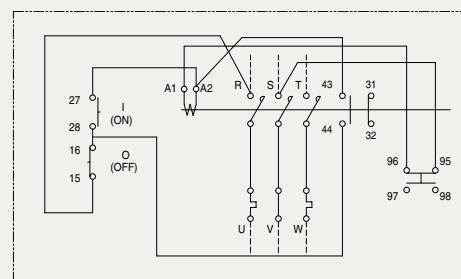

Enclosed motor starters, Steel enclosure dimension

[mm]

- MW-6a~100a
- MW-9b~22b

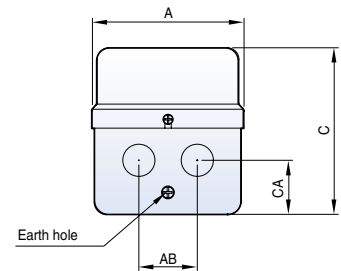
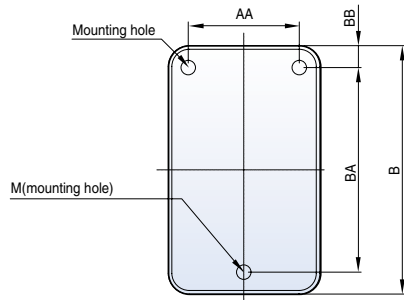

Type	A	AA	AB	B	BA	BB	C	CA	M	N	Weight(kg)
MW-9b~22b, 6a~18a	104	76	40	170	140	15	114	41	M5	Ø22	1.1
MW-32a, 40a	145	95	55	245	165	40	130	50	M5	Ø35	1.6
MW-50a, 65a	160	120	74	290	220	35	141	50	M5	Ø35	2.7
MW-75a, 85a, 100a	160	120	74	290	220	35	161	67	M5	Ø35	3.6

Circuit diagram

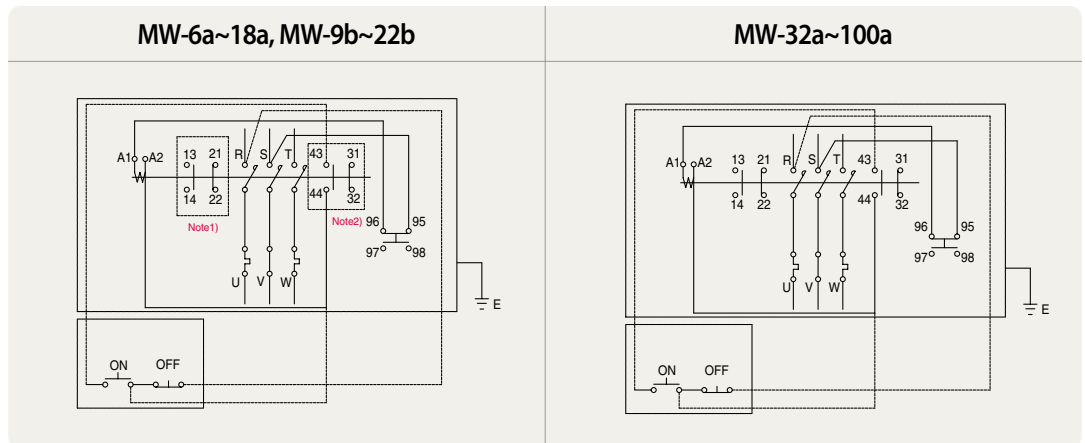

Note 1. In case of adding the auxiliary contact unit(1NO1NC).
 2. See below for MC-6a~18a(1NO)



Enclosed motor starters, Steel enclosure dimension

[mm]

- MW-6aB~100aB
- MW-9bB~22bB

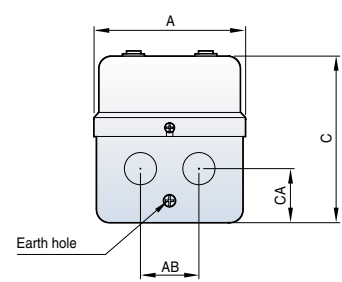
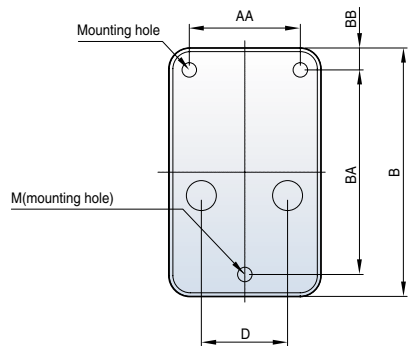

Type	A	AA	AB	B	BA	BB	C	CA	D	M	N	Weight(kg)
MW-9bB~22bB, 6aB~18aB	104	76	40	170	140	15	114	41	59	M5	Ø22	1.1
MW-32aB, 40aB	145	95	55	245	165	40	130	50	97	M5	Ø35	1.6
MW-50aB, 65aB	160	120	74	290	220	35	141	50	114	M5	Ø35	2.7
MW-75aB, 85aB, 100aB	160	120	74	290	220	35	161	67	114	M5	Ø35	3.6

Circuit diagram

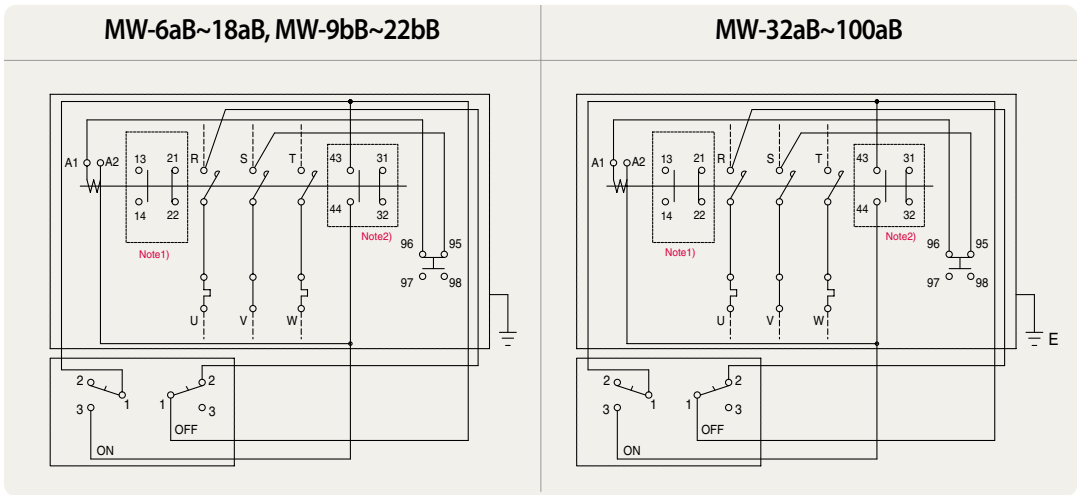

Note) 1. In case of adding the auxiliary contact unit(1NO1NC).
 2. See below for MC-6a~18a(1NO)



Capacitor contactors (MC-9b~40a with AC-9, MC 50a~100a with AC-50)

[mm]

MC-9b~22b with AC-9

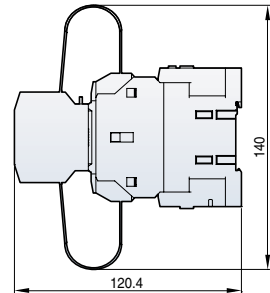
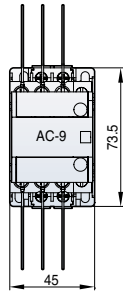

MC-32a,40a with AC-9

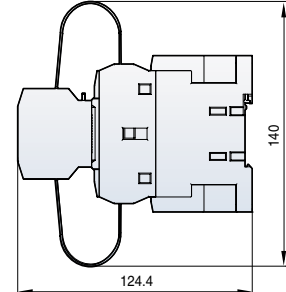
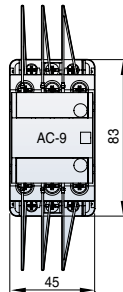

MC-50a,65a with AC-50

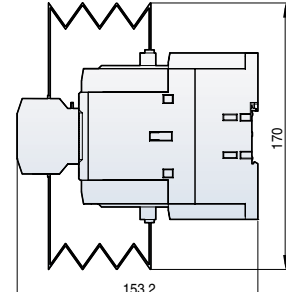
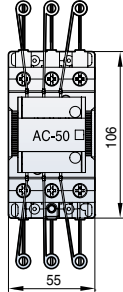

MC-75a~100a with AC-50

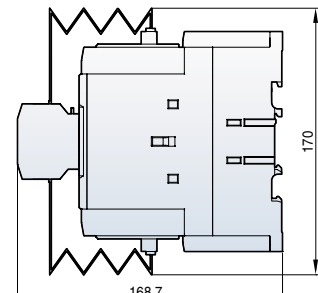
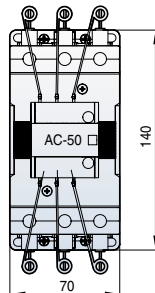

Circuit diagram

MC-9b~22b with AC-9

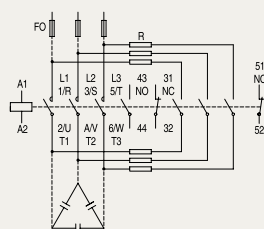

MC-32a, 40a with AC-9 MC 50a~100a with AC-50

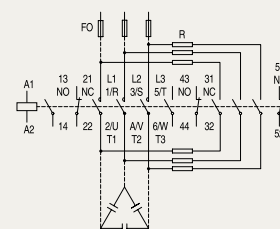

2-pole AC Contactors dimension (GMC-10P2~40P2)

- GMC-10P2
 - GMC-20P2
 - GMC-25P2
 - GMC-30P2
 - GMC-35P2
 - GMC-40P2
- (TSBS Type)

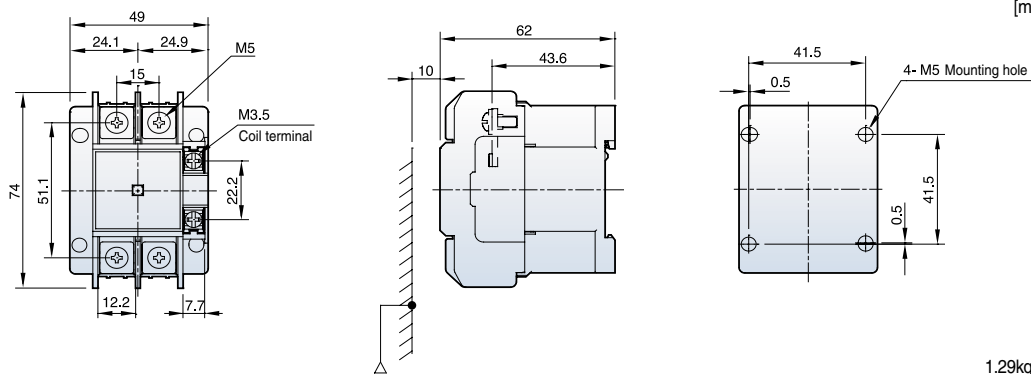

1.29kg

- GMC-10P2
 - GMC-20P2
 - GMC-25P2
 - GMC-30P2
 - GMC-35P2
 - GMC-40P2
- (TQBS Type)

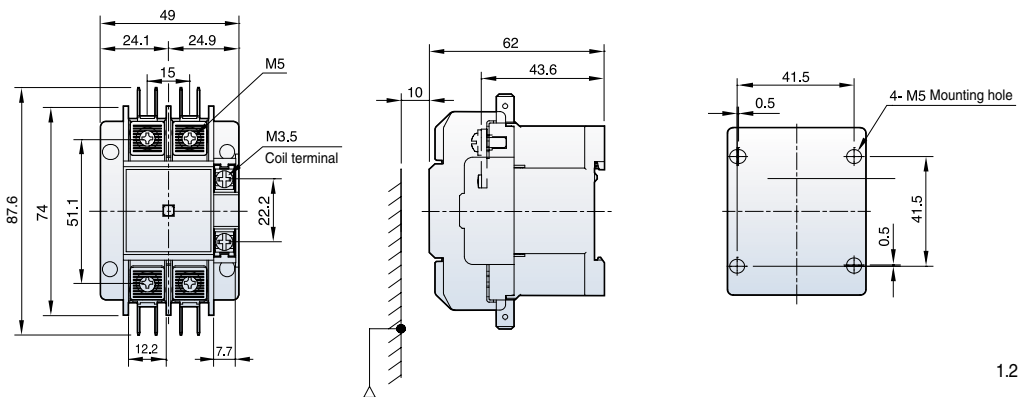

1.29kg

Composition

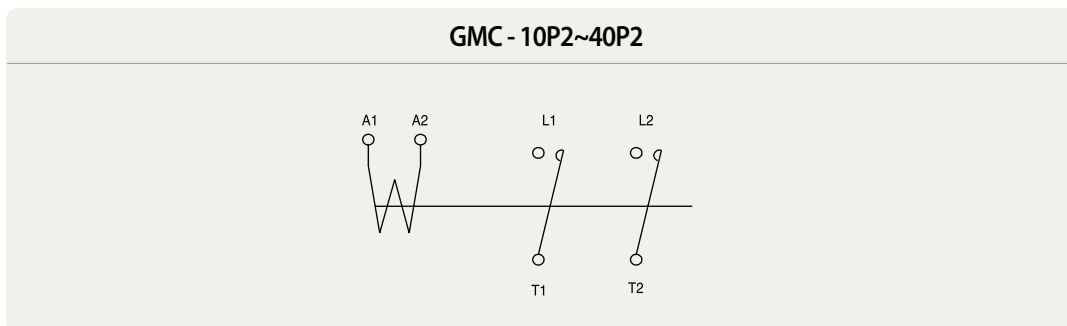

Terminal

Type	Terminals	Screw	Wire (mm ²)	Torque (kgf · cm)	A × B × C (mm)
GMC-10P2~40P2	Main	M5	1-16	26	12.2 × 7 × 8
	Coil	M3.5	1-2.5	12	7.7 × 7.5 × 4.5

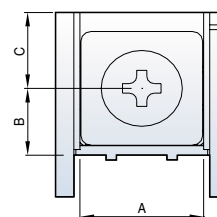

3-pole AC Contactors dimension (GMC-20D, 25D)

- GMC-20D
- GMC-25D

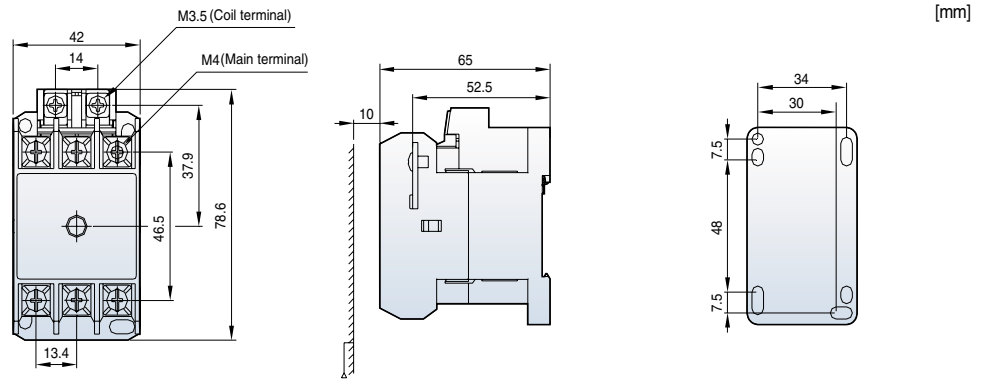

Contact arrangement

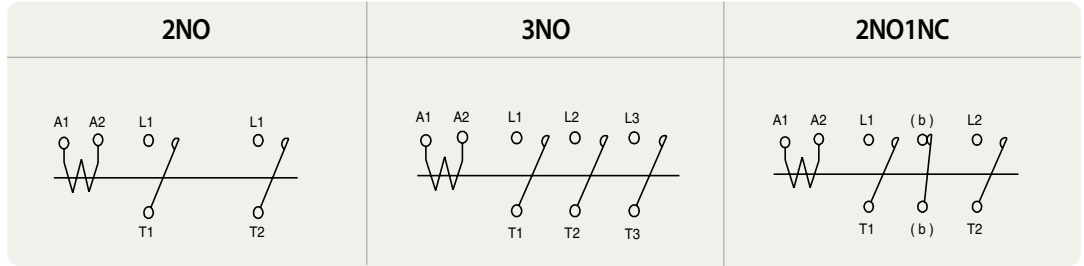

Terminal

Type	Screw	Wire (mm ²)	Torque (kgf · cm)	A × B × C (mm)
GMC-20D~25D	M4	1-10	15	9.4 × 5 × 85.1
Coil~	M3.5	1.25~2	12	8 × 5 × 4.9

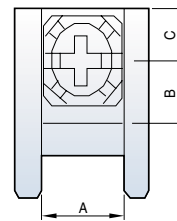

Single-pole AC Contactors (CH-6N/SP, 10N/SP)

- CH-6N/SP
- CH-10N/SP

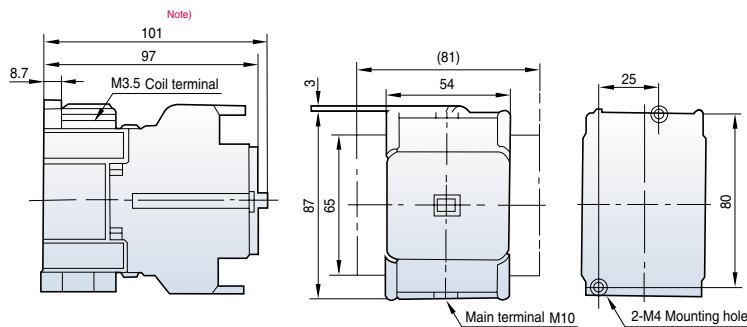

Composition

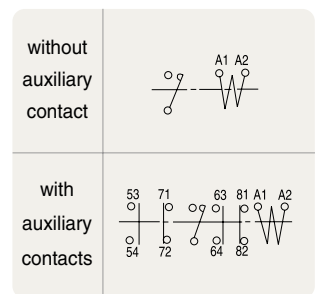

Note) In case of adding the auxiliary contact unit(2NO2NC)

0.62kg

DC Contactors dimension (MD-30a, 60a,100a)

[mm]

MD-30a AC(DC)

2NO2NC

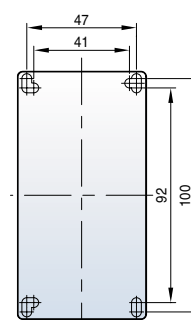
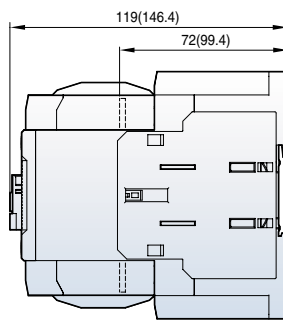
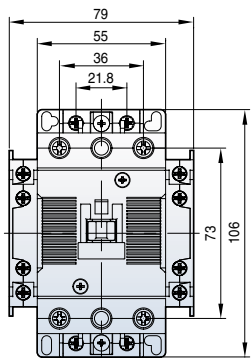

MD-60a,100a AC(DC)

2NO2NC

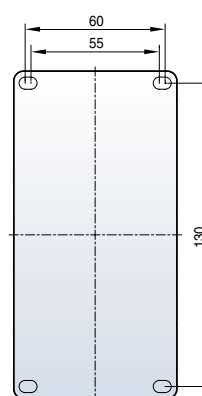
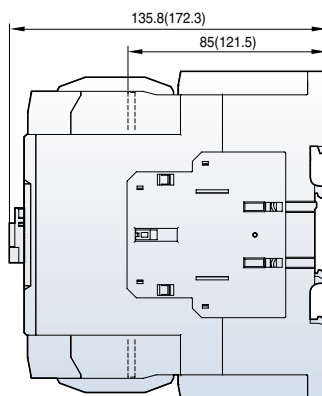
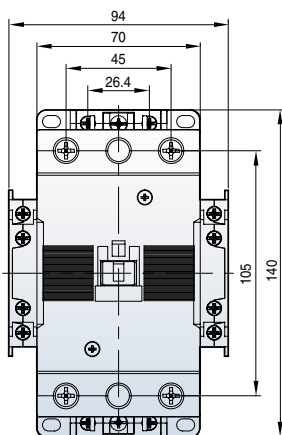

Composition

MD-30a, 60a, 100a

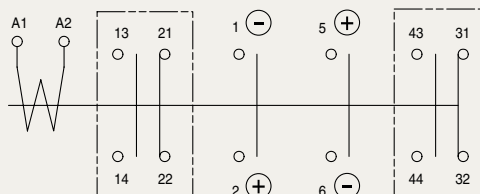

Contact arrangement

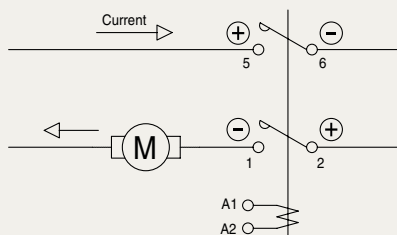

Overload relays dimension

MT-12

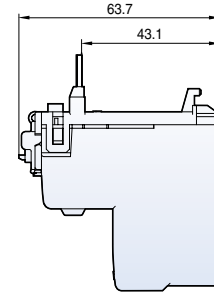
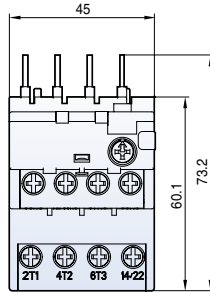

[mm]

100g

MT-32

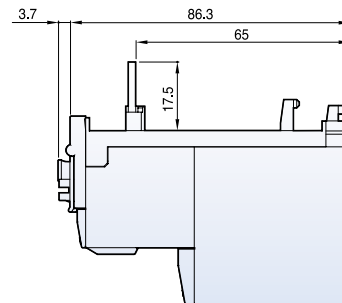
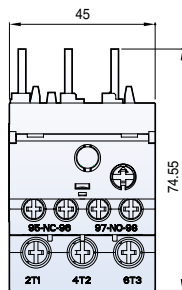

167g

MT-63

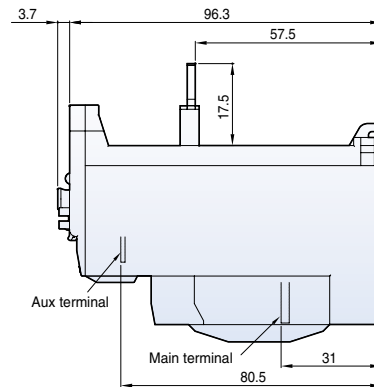
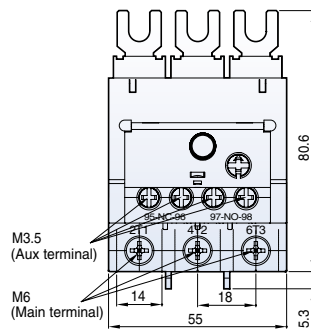

303g

MT-95

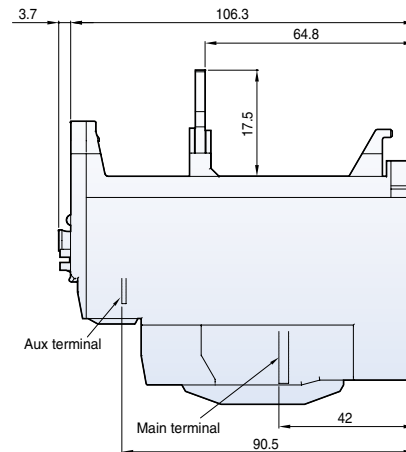
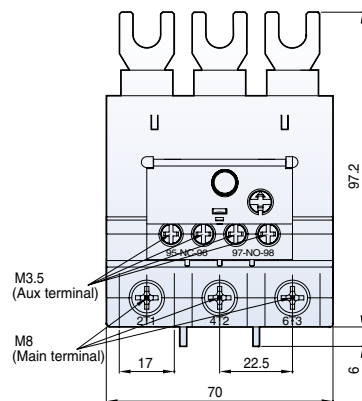

474g

Overload relays dimension

[mm]

MT-150

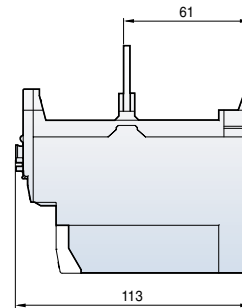
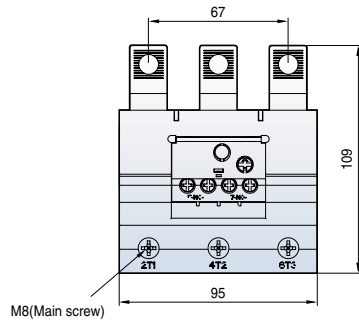

0.7kg

MT-225

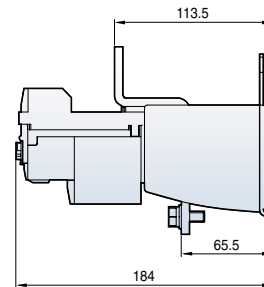
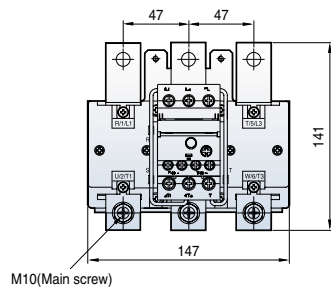

2.5kg

MT-400

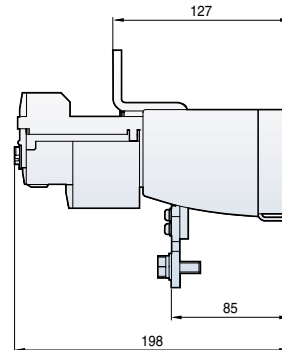
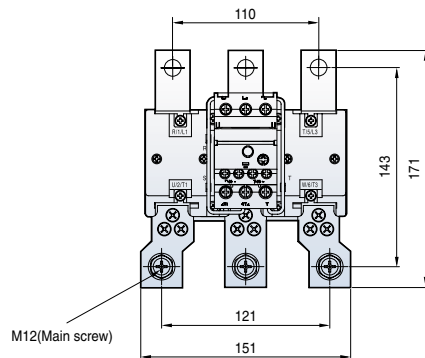

2.6kg

MT-800

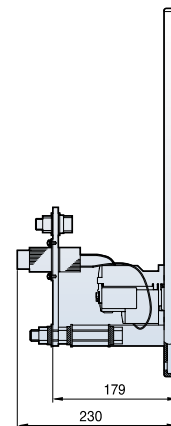
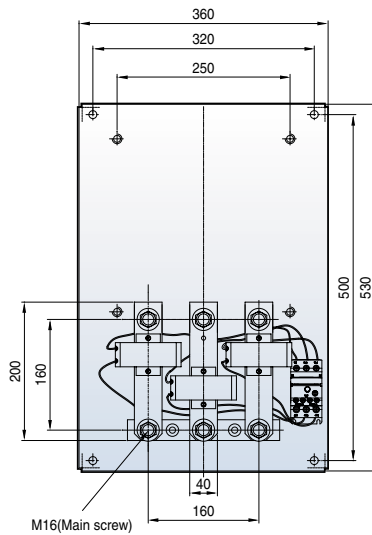

11.5kg

Overload relays dimension (Separate mount)

UZ-12

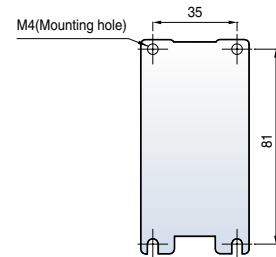
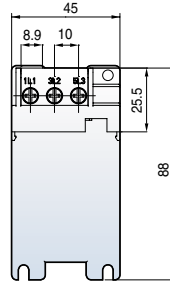
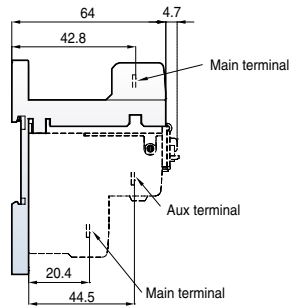

[mm]

35g

UZ-32

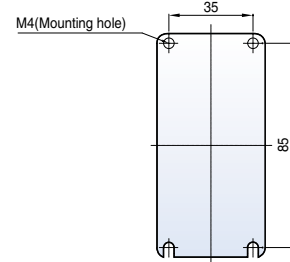
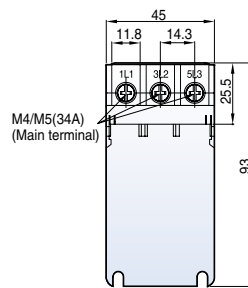
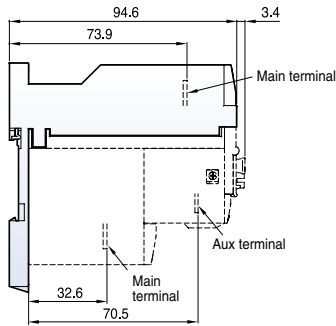

68g

UZ-63

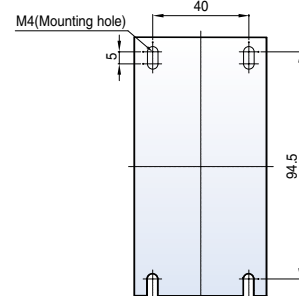
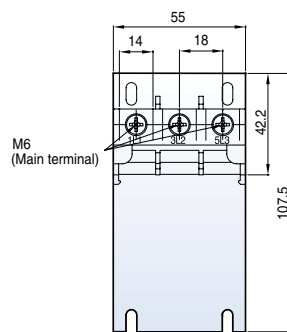
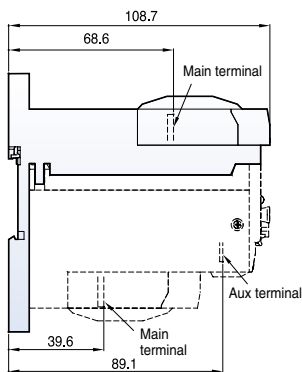

134g

Overload relays dimension (Separate mount)

[mm]

UZ-95

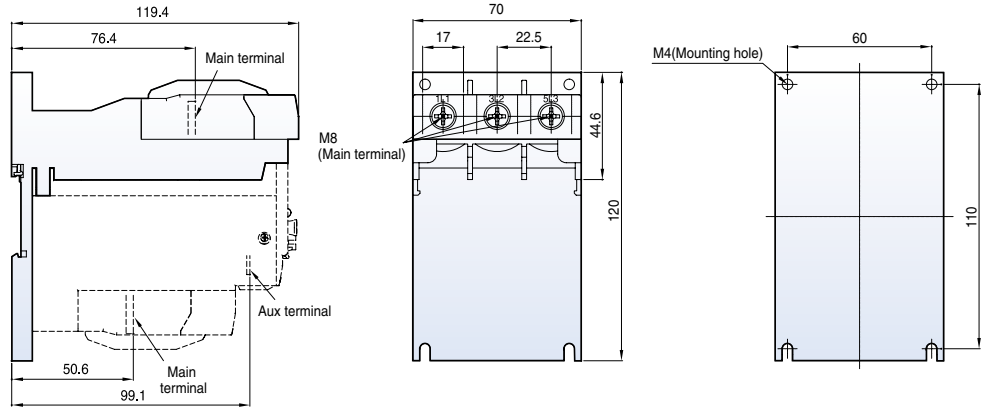

230g

UZ-150

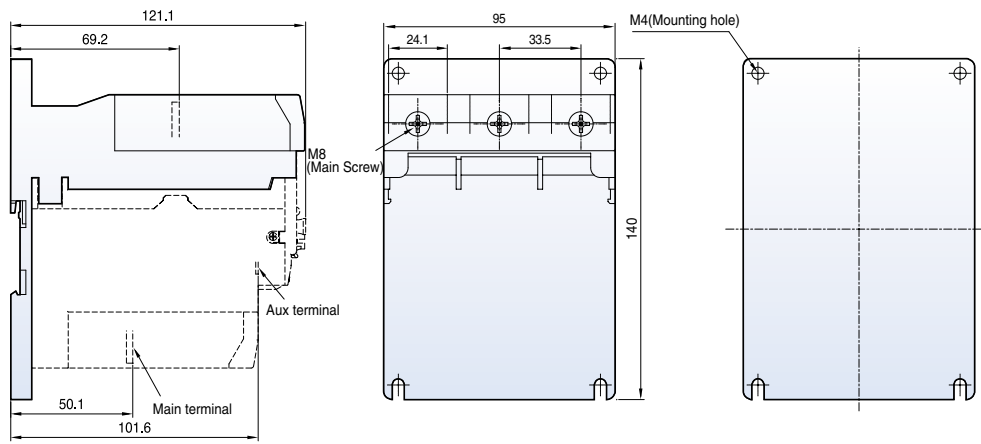

284g

Electronic timer unit

ON delay timer

On time(Close MC) delay of magnetic contactors 1~30sec

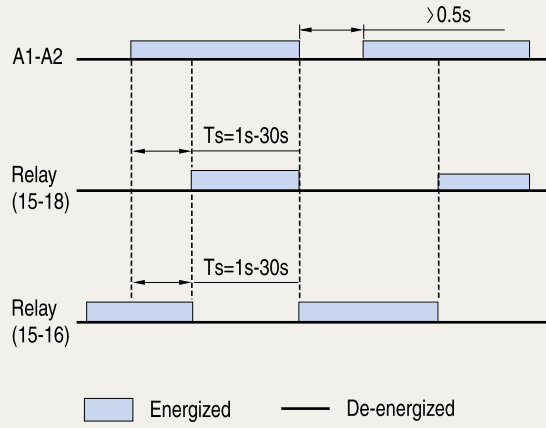

Circuit diagram

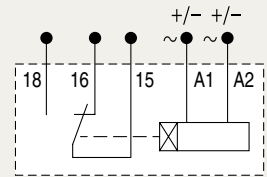

OFF delay timer

Off time(Open MC) delay of magnetic contactors 1~30sec

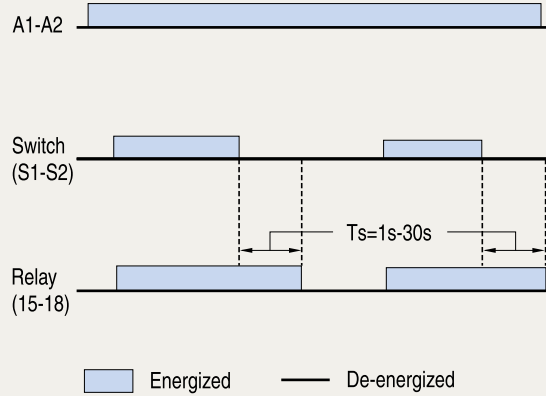

Circuit diagram

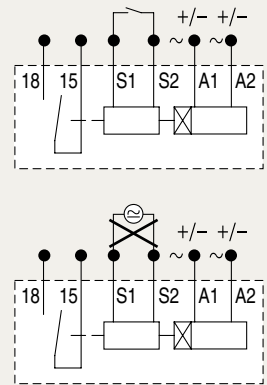

Dimension

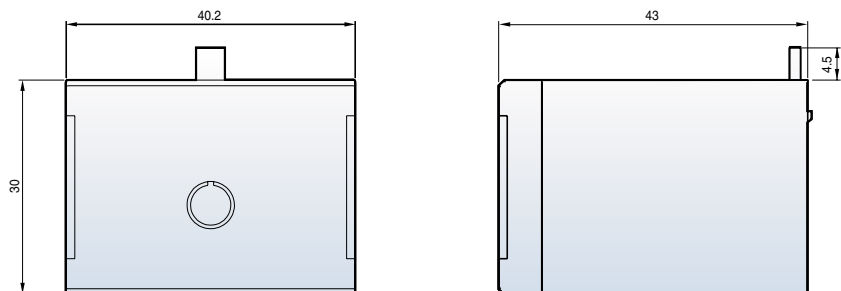

Contact arrangement

Contactors

MC-6a~18a

1NO

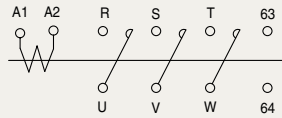

1NC

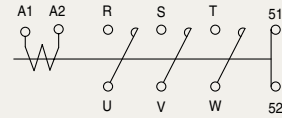

MC-9b~22b

1NO1NC

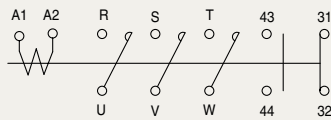

MC-32a~150a

2NO2NC

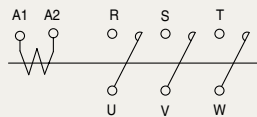
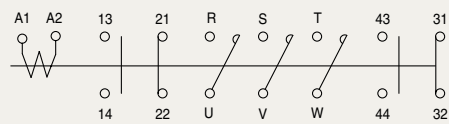

Contact arrangement

Motor starters

MS-6a~150a

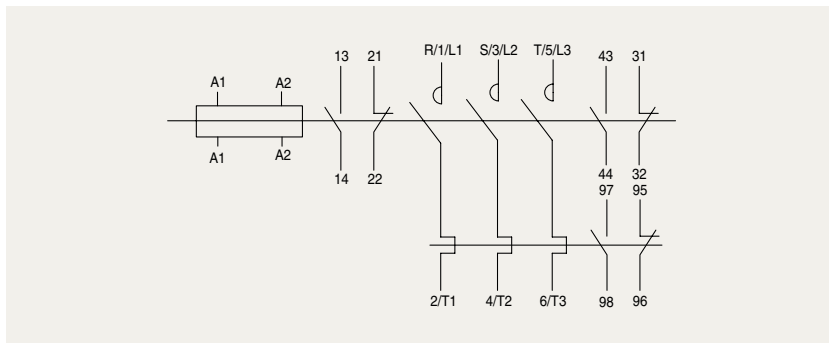
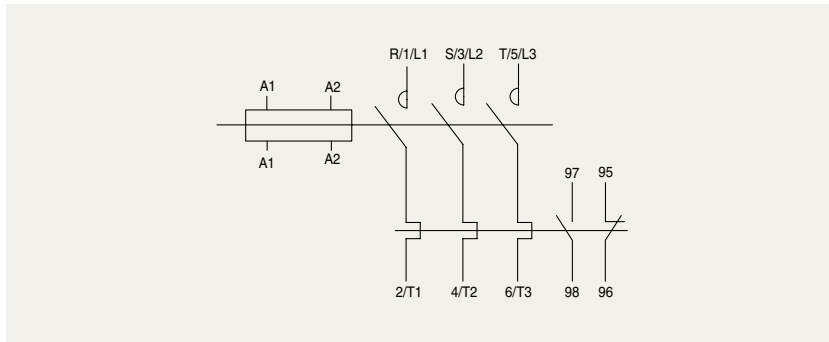

MS-185a~800a

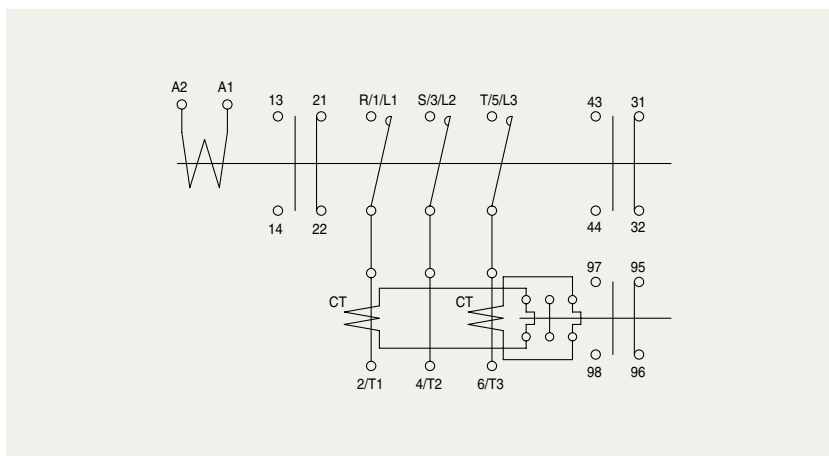

Meta-MEC and Metasol MC comparison table

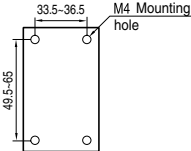
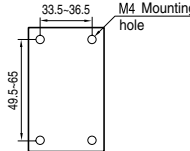
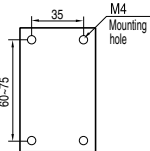
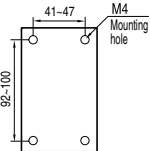
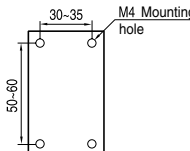
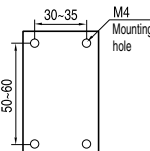
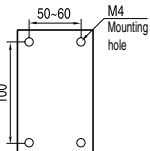
		Type	MC-6a	MC-9a	MC-12a	MC-18a	MC-9b	MC-12b	MC-18b	MC-22b	MC-32a	MC-40a	MC-50a	MC-65a	
Manufactured products	Metasol MC	Current and power AC3	200~240V	2.2kW 9A	2.5kW 11A	3.5kW 13A	4.5kW 18A	2.5kW 11A	3.5kW 13A	4.5kW 18A	5.5kW 22A	7.5kW 32A	11kW 40A	15kW 55A	18.5kW 65A
			380~440V	3kW 7A	4kW 9A	5.5kW 12A	7.5kW 18A	4kW 9A	5.5kW 12A	7.5kW 18A	11kW 22A	15kW 32A	18.5kW 40A	22kW 50A	30kW 65A
		500~550V	3kW 6A	4kW 7A	7.5kW 12A	7.5kW 13A	4kW 7A	7.5kW 12A	7.5kW 13A	15kW 20A	18.5kW 28A	22kW 32A	30kW 43A	33kW 60A	
	Auxiliary (Standard)		1NO or 1NC				1NO1NC				-		-		
	Mounting size														
	Weight (kg)		0.33				0.34				0.4		0.9		
	Dimension (W×H×D)		45 × 73.5 × 80.4				45 × 73.5 × 87.4				45 × 83 × 90		55 × 106 × 119		
Discontinued products	Meta-MEC MC	Current and power AC3	200~220V	-				2.5kW 11A	3.5kW 13A	4.5kW 18A	5.5kW 22A	7.5kW 32A	11kW 40A	15kW 55A	18.5kW 65A
			380~440V	-				4kW 9A	5.5kW 12A	7.5kW 18A	11kW 22A	15kW 32A	18.5kW 40A	22kW 50A	30kW 65A
		500~550V	-				4kW 7A	7.5kW 12A	7.5kW 13A	15kW 22A	18.5kW 28A	22kW 32A	30kW 43A	33kW 60A	
	Auxiliary (Standard)		-				1NO1NC	1NO1NC	1NO1NC	1NO1NC	2NO2NC	2NO2NC	2NO2NC	2NO2NC	
	Mounting size		-												
	Weight (kg)		-				0.33		0.37		0.45		1		
	Dimension (W×H×D)		-				44 × 80 × 86.8				68 × 82 × 94.6		94 × 122 × 115.7		
Compatibility with Metasol		-				○				×		×			

Note) Marks of compatibility
 ○ : can be compatible
 × : can't be compatible(have to use bracket)

MC-75a	MC-85a	MC-100a	MC-130a	MC-150a	MC-185a	MC-225a	MC-265a	MC-330a	MC-400a	MC-500a	MC-630a	MC-800a
22 kW 75A	25kW 85A	30kW 105A	37kW 130A	45kW 150A	55kW 185A	75kW 225A	80kW 265A	90kW 330A	125kW 400A	147kW 500A	190kW 630A	220kW 800A
37 kW 75A	45kW 85A	55kW 105A	60kW 130A	75kW 150A	90kW 185A	132kW 225A	147kW 265A	160kW 330A	200kW 400A	265kW 500A	330kW 630A	440kW 800A
37 kW 64A	45 kW 75A	55kW 85A	60kW 90A	70kW 100A	110kW 180A	132kW 200A	147kW 225A	160kW 280A	225kW 350A	265kW 400A	330kW 500A	500kW 720A
-	-	2NO2NC		2NO2NC		2NO2NC		2NO2NC		2NO2NC		
1.6	2.4	5.4		9.2		22.4						
70 × 140 × 135.8		95 × 158 × 130.3		138 × 203 × 185.1		163 × 243 × 204.4		285 × 312 × 245.3				
GMC-75	GMC-85	GMC-100	GMC-125	GMC-150	GMC-180	GMC-220	-	GMC-300	GMC-400	-	GMC-600	GMC-800
22kW 75A	25kW 85A	30kW 105A	37kW 125A	45kW 150A	55kW 180A	75kW 250A	-	90kW 300A	125kW 400A	-	190kW 630A	220kW 800A
37kW 75A	45kW 85A	55kW 105A	60kW 120A	75kW 150A	90kW 180A	132kW 250A	-	160kW 300A	200kW 400A	-	330kW 630A	440kW 800A
37kW 64A	45kW 75A	55kW 85A	60kW 90A	90kW 140A	110kW 180A	132kW 200A	-	160kW 250A	225kW 350A	-	330kW 500A	500kW 720A
2NO2NC	2NO2NC	2NO2b	2NO2NC	2NO2NC	2NO2NC	2NO2NC	-	2NO2NC	2NO2NC	-	2NO2NC	2NO2NC
1	2.9	3.4	5.4	-	9.2	-	22					
94 × 122 × 115.7		100 × 157.4 × 146.5		120 × 166 × 157		138 × 203 × 181		163 × 243 × 198		285 × 290 × 242		
×		×		○		-		○		-		

Meta-MEC and Metasol MS comparison table

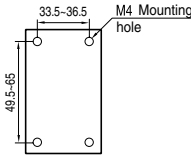
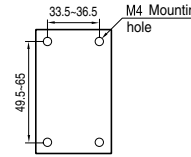
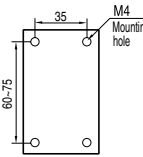
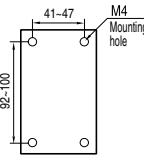
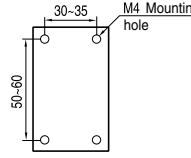
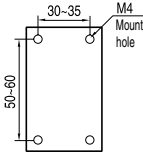
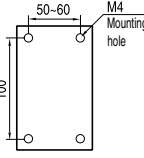
		Type	MS-6a	MS-9a	MS-12a	MS-18a	MS-9b	MS-12b	MS-18b	MS-22b	MS-32a	MS-40a	MS-50a	MS-65a	
Manufactured products	Metasol MC	Current and power AC3	200~240V	2.2kW 9A	2.5kW 11A	3.5kW 13A	4.5kW 18A	2.5kW 11A	3.5kW 13A	4.5kW 18A	5.5kW 22A	7.5kW 32A	11kW 40A	15kW 55A	18.5kW 65A
			380~440V	3kW 7A	4kW 9A	5.5kW 12A	7.5kW 18A	4kW 9A	5.5kW 12A	7.5kW 18A	11kW 22A	15kW 32A	18.5kW 40A	22kW 50A	30kW 65A
		500~550V	3kW 6A	4kW 7A	7.5kW 12A	7.5kW 13A	4kW 7A	7.5kW 12A	7.5kW 13A	15kW 20A	18.5kW 28A	22kW 32A	30kW 43A	33kW 60A	
	Auxiliary (Standard)		1NO or 1NC				1NO1NC				-		-		
	Mounting size														
	Weight (kg)		0.5				0.5				0.7		1.5		
	Dimension (W×H×D)		45 × 124 × 80.4				45 × 129.9 × 87.4				45 × 139.4 × 90		55 × 163.8 × 119		
Discontinued products	Meta-MEC MC	Current and power AC3	200~220V	-				2.5kW 11A	3.5kW 13A	4.5kW 18A	5.5kW 22A	7.5kW 32A	11kW 40A	15kW 55A	18.5kW 65A
			380~440V	-				4kW 9A	5.5kW 12A	7.5kW 18A	11kW 22A	15kW 32A	18.5kW 40A	22kW 50A	30kW 65A
			500~550V	-				4kW 7A	7.5kW 12A	7.5kW 13A	15kW 22A	18.5kW 28A	22kW 32A	30kW 43A	33kW 60A
	Auxiliary (Standard)		-				1NO1NC	1NO1NC	1NO1NC	1NO1NC	2NO2NC	2NO2NC	2NO2NC	2NO2NC	
	Mounting size		-												
	Weight (kg)		-				0.46		0.5		0.45		1.12		
	Dimension (W×H×D)		-				44 × 128.9 × 86.8				68 × 136.5 × 94.6		94 × 181.5 × 115.7		
Compatibility with Metasol		-				○				×		×			

Note) Marks of compatibility
 ○ : can be compatible
 × : can't be compatible(have to use bracket)

MS-75a	MS-85a	MS-100a	MS-130a	MS-150a	MS-185a	MS-225a	MS-265a	MS-330a	MS-400a	MS-500a	MS-630a	MS-800a
22 kW 75A	25kW 85A	30kW 105A	37kW 130A	45kW 150A	55kW 185A	75kW 225A	80kW 265A	90kW 330A	125kW 400A	147kW 500A	190kW 630A	220kW 800A
37 kW 75A	45kW 85A	55kW 105A	60kW 130A	75kW 150A	90kW 185A	132kW 225A	147kW 265A	160kW 330A	200kW 400A	265kW 500A	330kW 630A	440kW 800A
37 kW 64A	45 kW 75A	55kW 85A	60kW 90A	70kW 100A	110kW 180A	132kW 200A	147kW 225A	160kW 280A	225kW 350A	265kW 400A	330kW 500A	500kW 720A
-			-			2NO2NC		2NO2NC		2NO2NC		
2.4		3		7.9		11.8		28				
70 × 211.4 × 135.8		95 × 236.2 × 130.3		138 × 306.5 × 185.1		163 × 380 × 204.4		360 × 530 × 245.3				
GMC-75	GMC-85	GMC-100	GMC-125	GMC-150	GMC-180	GMC-220	-	GMC-300	GMC-400	-	GMC-600	GMC-800
22kW 75A	25kW 85A	30kW 105A	37kW 125A	45kW 150A	55kW 180A	75kW 250A	-	90kW 300A	125kW 400A	-	190kW 630A	220kW 800A
37kW 75A	45kW 85A	55kW 105A	60kW 120A	75kW 150A	90kW 180A	132kW 250A	-	160kW 300A	200kW 400A	-	330kW 630A	440kW 800A
37kW 64A	45kW 75A	55kW 85A	60kW 90A	90kW 140A	110kW 180A	132kW 200A	-	160kW 250A	225kW 350A	-	330kW 500A	500kW 720A
2NO2NC	2NO2NC	2NO2NC	2NO2NC	2NO2NC	2NO2NC	2NO2NC	-	2NO2NC	2NO2NC	-	2NO2NC	2NO2NC
1.12		3.4		4		7.9		11.8		28		
94 × 181.5 × 115.7		114 × 231.4 × 146.5		120 × 206.4 × 157		138 × 306.54 × 181		163 × 380 × 198		360 × 530 × 262		
×		×		○		-		○		-		○

Meta-MEC and Metasol relays comparison table

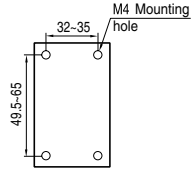
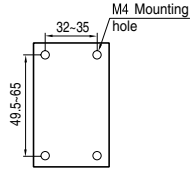
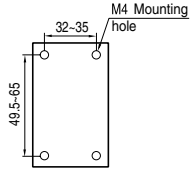
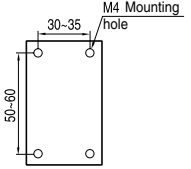
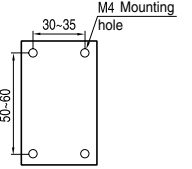
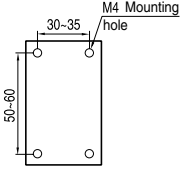
		Type	MR-4	MR-6	MR-8	
Manufactured products	Metasol MR	Auxiliary (kW)	4NO, 3NO1NC, 2NO2NC 1NO3NC, 4NC	6NO, 5NO1NC, 4NO2NC 3NO3NC, 2NO4NC	8NO, 7NO1NC, 6NO2NC 5NO3NC, 4NO4NC	
		Rated current (A)	120 V	6	6	6
		AC15	240 V	3	3	3
		Mounting size				
		Dimension (W×H×D)	45×73.5×79(96.6)	45×73.5×109.6(127.2)	45×73.5×109.6(127.2)	
		Weight (kg)	0.284	0.315	0.339	
Discontinued products	GMR	Auxiliary (kW)	4NO, 3NO1NC, 2NO2NC 1NO3NC, 4NC	6NO, 5NO1NC, 4NO2NC 3NO3NC, 2NO4NC	8NO, 7NO1NC, 6NO2NC 5NO3NC, 4NO4NC	
		Rated current (A)	AC110V	6	6	6
		AC11	AC220V	5	5	5
		Mounting size				
		Dimension (W×H×D)	44×80×86.8(113.2)	44×80×118.6(145)	44×80×118.6(145)	
		Weight (kg)	0.34(0.56)	0.37(0.59)	0.39(0.61)	

Meta-MEC and Metasol TOR comparison table







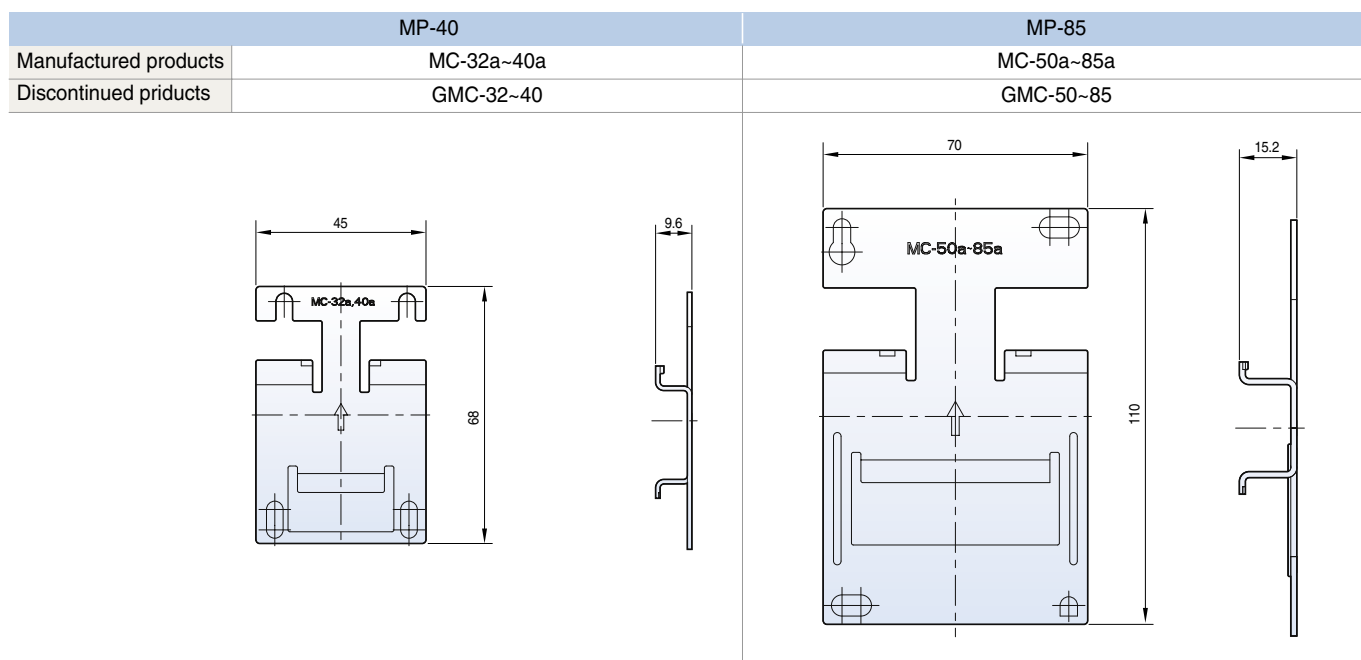

Manufactured products		Discontinued products	
MT		GTH (K)	
MT-12	0.14(0.1~0.16), 0.21(0.16~0.25), 0.33(0.25~0.4), 0.52(0.4~0.63), 0.82(0.63~1), 1.3(1~1.6), 2.1(1.6~2.5), 3.3(2.5~4), 5(4~6), 6.5(5~8), 7.5(6~9), 8.5(7~10), 11(9~13), 15(12~18), 19(16~22)	GTH(K)-22	0.14(0.1~0.16), 0.21(0.16~0.25), 0.33(0.25~0.4), 0.52(0.4~0.63), 0.82(0.63~1), 1.3(1~1.6), 2.1(1.6~2.5), 3.3(2.5~4), 5(4~6), 6.5(5~8), 7.5(6~9), 8.5(7~10), 11(9~13), 15(12~18), 19(16~22)
MT-32	0.14(0.1~0.16), 0.21(0.16~0.25), 0.33(0.25~0.4), 0.52(0.4~0.63), 0.82(0.63~1), 5(4~6), 6.5(5~8), 7.5(6~9), 8.5(7~10), 11(9~13), 15(12~18), 19(16~22), 22(18~26), 34(28~40)	GTH(K)-40	5(4~6), 6.5(5~8), 7.5(6~9), 8.5(7~10), 11(9~13), 15(12~18), 19(16~22), 22(18~26), 30(24~36), 34(28~40)
MT-63	5(4~6), 6.5(5~8), 7.5(6~9), 8.5(7~10), 11(9~13), 15(12~18), 19(16~22), 22(18~26), 30(24~36), 34(28~40), 42(34~50), 54(45~65)	GTH(K)-85	8.5(7~10), 11(9~13), 15(12~18), 19(16~22), 22(18~26), 30(24~36), 34(28~40), 42(34~50), 55(45~65), 65(54~75), 74(63~85)
MT-95	8.5(7~10), 11(9~13), 15(12~18), 19(16~22), 22(18~26), 30(24~36), 34(28~40), 42(34~50), 54(45~65), 65(54~75), 74(63~85), 83(70~95), 90(80~100)	GTH(K)-100	41(34~50), 48(39~57), 56(43~65), 67(54~80), 80(65~100), 107(85~125)
MT-150	42(34~50), 55(45~65), 65(54~75), 74(63~85), 93(80~105), 113(95~130), 130(110~150)	GTH(K)-150	41(34~50), 48(39~57), 56(43~65), 67(54~80), 80(65~100), 107(85~125), 130(100~150)
MT-225	80(65~100), 107(85~125), 130(100~160), 153(120~185), 200(160~240)	GTH(K)-220	80(65~100), 107(85~125), 130(100~160), 150(120~180), 200(160~240)
MT-400	107(85~125), 130(100~160), 153(120~185), 200(160~240), 265(200~330), 350(260~400)	GTH(K)-400	107(85~125), 130(100~160), 150(120~180), 200(160~240), 250(200~300), 350(260~400)
MT-800	265(200~300), 350(260~400), 515(400~630), 660(520~800)	GTH(K)-600	250(200~300), 350(260~400), 500(400~600), 660(520~800)

Compatibility bracket

- Mounting Metasol MC on Din-Rail of bracket after install the bracket on panel
- Please use compatibility bracket when replace from Meta-MEC to Metasol MC without to change of panel size











Certifications

Type		Approvals					Certificates		
		Certificate	IEC	UL	CSA	GB	IEC		KEPIC
Mark and name									
Type		Korea	Europe	U.S.A & Canada	Canada	China	Netherlands	Denmark	Korea
Metasol Contactors	MC-6a	●	●	●	●	●	●		●
	MC-9a	●	●	●	●	●	●		●
	MC-12a	●	●	●	●	●	●		●
	MC-18a	●	●	●	●	●	●		●
	MC-9b	●	●	●	●	●	●	●	●
	MC-12b	●	●	●	●	●	●	●	●
	MC-18b	●	●	●	●	●	●	●	●
	MC-22b	●	●	●	●	●	●	●	●
	MC-32a	●	●	●	●	●	●	●	●
	MC-40a	●	●	●	●	●	●		●
	MC-50a	●	●	●	●	●	●		●
	MC-65a	●	●	●	●	●	●		●
	MC-75a	●	●	●	●	●	●		●
	MC-85a	●	●	●	●	●	●		●
	MC-100a	●	●	●	●	●	●		●
	MC-130a	●	●	●	●	●	●		●
	MC-150a	●	●	●	●	●	●		●
	MC-185a	●	●	●	●	●	●		●
	MC-225a	●	●	●	●	●	●		●
	MC-265a	●	●	●	●	●	●		●
MC-330a		●	●	●	●	●		●	
MC-400a		●	●	●	●	●		●	
MC-500a		●	●	●	●	●		●	
MC-630a		●	●	●	●	●		●	
MC-800a		●	●	●	●	●		●	
Thermal Overload Relays Nondifferential (2-heater)	MT-12/2H		●	●			●		●
	MT-32/2H		●	●	●		●		●
	MT-63/2H		●	●	●	●	●		●
	MT-95/2H		●	●	●	●	●		●
	MT-150/2H		●	●	●		●		●
	MT-225/2H		●	●	●		●		●
	MT-400/2H		●	●	●		●		●
MT-800/2H		●	●	●		●		●	
Thermal Overload Relays Nondifferential (3-heater)	MT-12/3H		●	●			●		●
	MT-32/3H		●	●	●	●	●		●
	MT-63/3H		●	●	●	●	●		●
	MT-95/3H		●	●	●	●	●		●
	MT-150/3H		●	●	●		●		●
	MT-225/3H		●	●	●		●		●
	MT-400/3H		●	●	●		●		●
MT-800/3H		●	●	●		●		●	
Thermal Overload Relays Differential	MT-12/3K		●	●			●		●
	MT-32/3K		●	●	●	●	●		●
	MT-63/3K		●	●	●	●	●		●
	MT-95/3K		●	●	●	●	●		●
	MT-150/3K		●	●	●		●		●
	MT-225/3K		●	●	●		●		●
	MT-400/3K		●	●	●		●		●
MT-800/3K		●	●	●		●		●	
Thermal Overload Relays Class 20	MT-12/3D		●	●			●		●
	MT-32/3D		●	●	●	●	●		●
	MT-63/3D		●	●	●	●	●		●
	MT-95/3D		●	●	●	●	●		●
	MT-150/3D		●	●	●		●		●
	MT-225/3D		●	●	●		●		●
MT-400/3D		●	●	●		●		●	
MT-800/3D		●	●	●		●		●	

Note) ● : Completion

Marine certifications

Type		Approvals							
		 KR Korea	 LR U.K	 BV France	 GL Germany	 DNV Norway	 ABS U.S.A	 NK Japan	 RINA Italy
Metasol Contactors	MC-6a	●	●	●	●	●	●	●	●
	MC-9a	●	●	●	●	●	●	●	●
	MC-12a	●	●	●	●	●	●	●	●
	MC-18a	●	●	●	●	●	●	●	●
	MC-9b	●	●	●	●	●	●	●	●
	MC-12b	●	●	●	●	●	●	●	●
	MC-18b	●	●	●	●	●	●	●	●
	MC-22b	●	●	●	●	●	●	●	●
	MC-32a	●	●	●	●	●	●	●	●
	MC-40a	●	●	●	●	●	●	●	●
	MC-50a	●	●	●	●	●	●	●	●
	MC-65a	●	●	●	●	●	●	●	●
	MC-75a	●	●	●	●	●	●	●	●
	MC-85a	●	●	●	●	●	●	●	●
	MC-100a	●	●	●	●	●	●	●	●
	MC-130a	●	●	●	●	●	●	●	●
	MC-150a	●	●	●	●	●	●	●	●
	MC-185a	●	●	●	●	●	●	●	●
	MC-225a	●	●	●	●	●	●	●	●
	MC-265a	●	●	●	●	●	●	●	●
MC-330a	●	●	●	●	●	●	●	●	
MC-400a	●	●	●	●	●	●	●	●	
MC-500a	●	●	●	●	●	●	●	●	
MC-630a	●	●	●	●	●	●	●	●	
MC-800a	●	●	●	●	●	●	●	●	
Thermal Overload Relays Nondifferential (2-heater)	MT-12/2H	●	●	●	●	●	●	●	●
	MT-32/2H	●	●	●	●	●	●	●	●
	MT-63/2H	●	●	●	●	●	●	●	●
	MT-95/2H	●	●	●	●	●	●	●	●
	MT-150/2H	●	●	●	●	●	●	●	●
	MT-225/2H	●	●	●	●	●	●	●	●
	MT-400/2H	●	●	●	●	●	●	●	●
MT-800/2H	●	●	●	●	●	●	●	●	
Thermal Overload Relays Nondifferential (3-heater)	MT-12/3H	●	●	●	●	●	●	●	●
	MT-32/3H	●	●	●	●	●	●	●	●
	MT-63/3H	●	●	●	●	●	●	●	●
	MT-95/3H	●	●	●	●	●	●	●	●
	MT-150/3H	●	●	●	●	●	●	●	●
	MT-225/3H	●	●	●	●	●	●	●	●
	MT-400/3H	●	●	●	●	●	●	●	●
MT-800/3H	●	●	●	●	●	●	●	●	
Thermal Overload Relays Differential	MT-12/3K	●	●	●	●	●	●	●	●
	MT-32/3K	●	●	●	●	●	●	●	●
	MT-63/3K	●	●	●	●	●	●	●	●
	MT-95/3K	●	●	●	●	●	●	●	●
	MT-150/3K	●	●	●	●	●	●	●	●
	MT-225/3K	●	●	●	●	●	●	●	●
	MT-400/3K	●	●	●	●	●	●	●	●
MT-800/3K	●	●	●	●	●	●	●	●	
Thermal Overload Relays Class 20	MT-12/3D	●	●	●	●	●	●	●	●
	MT-32/3D	●	●	●	●	●	●	●	●
	MT-63/3D	●	●	●	●	●	●	●	●
	MT-95/3D	●	●	●	●	●	●	●	●
	MT-150/3D	●	●	●	●	●	●	●	●
	MT-225/3D	●	●	●	●	●	●	●	●
MT-400/3D	●	●	●	●	●	●	●	●	
MT-800/3D	●	●	●	●	●	●	●	●	

Note) ● : Completion

LSMS



<Android>



<IOS>

This application is selection guide of motor starter, overload relays and MCCBs

Green Innovators of Innovation



Safety Instructions

- For your safety, please read user's manual thoroughly before operating.
- Contact the nearest authorized service facility for examination, repair, or adjustment.
- Please contact a qualified service technician when you need maintenance. Do not disassemble or repair by yourself!
- Any maintenance and inspection shall be performed by the personnel having expertise concerned.

LSIS Co., Ltd.

© 2008.10 LSIS Co.,Ltd. All rights reserved.

www.lsis.com

■ HEAD OFFICE

LS-ro 127 (Hogye-dong) dongan-gu Anyang-si
Gyeonggi-do Korea
Tel. (82-2)2034-4887, 4873, 4918, 4148
Fax. (82-2)2034-4648

■ CHEONG-JU PLANT

Cheong-Ju Plant #1, Song Jung Dong, Hung Duk Ku,
Cheong Ju, 361-720, Korea

■ Global Network

- **LSIS (Middle East) FZE >> Dubai, U.A.E.**
Address: LOB 19 JAFZA VIEW TOWER Room 205, Jebel Ali Freezone P.O. Box 114216, Dubai, United Arab Emirates
Tel: 971-4-886 5360 Fax: 971-4-886-5361 e-mail: dhleef@lsis.biz
- **Dalian LSIS Co., Ltd. >> Dalian, China**
Address: No.15, Liaohexi 3-Road, Economic and Technical Development zone, Dalian 116600, China
Tel: 86-411-8273-7777 Fax: 86-411-8730-7560 e-mail: tangyh@lsis.com.cn
- **LSIS (Wuxi) Co., Ltd. >> Wuxi, China**
Address: 102-A, National High & New Tech Industrial Development Area, Wuxi, Jiangsu, 214028, P.R.China
Tel: 86-510-8534-6666 Fax: 86-510-522-4078 e-mail: luw@lsis.com.cn
- **LSIS-VINA Co., Ltd. >> Hanoi, Vietnam**
Address: Nguyen Khe - Dong Anh - Ha Noi - Viet Nam
Tel: 84-4-882-0222 Fax: 84-4-882-0220 e-mail: sjbaik@lsis.biz
- **LSIS-VINA Co., Ltd. >> Hochiminh, Vietnam**
Address: 41 Nguyen Thi Minh Khai Str. Yoco Bldg 4th Floor, Hochiminh City, Vietnam
Tel: 84-8-3822-7941 Fax: 84-8-3822-7942 e-mail: hjchoid@lsis.biz
- **LSIS Shanghai Office >> Shanghai, China**
Address: Room 32 floors of the Great Wall Building, No. 3000 North Zhongshan Road, Putuo District, Shanghai, China
Tel: 86-21-5237-9977 Fax: 89-21-5237-7189 e-mail: baijh@lsis.com.cn
- **LSIS Beijing Office >> Beijing, China**
Address: B-Tower 17FL.Beijing Global Trade Center B/D. No.36, BeiSanHuanDong-Lu, DongCheng-District, Beijing 100013, P.R. China
Tel: 86-10-5825-6025,7 Fax: 86-10-5825-6026 e-mail: sunmj@lsis.com.cn
- **LSIS Guangzhou Office >> Guangzhou, China**
Address: Room 1403, 14/F, New Poly Tower, No.2 Zhongshan Liu Road, Guangzhou 510180, P.R. China
Tel: 020-8326-6754 Fax: 020-8326-6287 e-mail: chenxs@lsis.com.cn
- **LSIS Chengdu Office >> Chengdu, China**
Address: Room 1701 17Floor, huamin hanjun international Building, No1 Fuxing Road Chengdu, 610016, P.R. China
Tel: 86-28-8670-3201 Fax: 86-28-8670-3203 e-mail: yanggf@lsis.com.cn
- **LSIS Qingdao Office >> Qingdao, China**
Address: Room 2001,20/F,7B40, Galaxy Building, No.29 Shandong Road, Shinan District, Qingdao 266071, P.R. China
Tel: 86-532-8501-6058 Fax: 86-532-8501-6057 e-mail: wangzy@lsis.com.cn
- **LSIS NETHERLANDS Co.Ltd >> Schiphol-Rijk, Netherlands**
Address: 1st. Floor, Tupolevlaan 48, 1119NZ, Schiphol-Rijk, The Netherlands
Tel: 31-20-654-1420 Fax: 31-20-654-1429 e-mail: junshickp@lsis.biz
- **LSIS Gurgaon Office >> Gurgaon, India**
Address: 109 First Floor, Park Central, Sector-30, Gurgaon- 122 002, Haryana, India e-mail: hwyim@lsis.biz

Specifications in this catalog are subject to change without notice due to continuous product development and improvement.